

ASSESSORS' HANDBOOK
SECTION 534

RURAL BUILDING COSTS

DECEMBER 2022

(USE FOR LIEN DATE JANUARY 1, 2023)

CALIFORNIA STATE BOARD OF EQUALIZATION

TED GAINES, SACRAMENTO

MALIA M. COHEN, CHAIR, SAN FRANCISCO

ANTONIO VAZQUEZ, SANTA MONICA

MIKE SCHAEFER, VICE CHAIR, SAN DIEGO

BETTY T. YEE

FIRST DISTRICT

SECOND DISTRICT

THIRD DISTRICT

FOURTH DISTRICT

STATE CONTROLLER

YVETTE M. STOWERS, EXECUTIVE DIRECTOR



FOREWORD

The 2023 revision of Assessors' Handbook Section 534, *Rural Building Costs* (AH 534), updates costs contained in previous editions. These costs become effective as of January 1, 2023. The 2023 revision of AH 534 is available only on the State Board of Equalization's (BOE) website. The entire text, photographs, and drawings of AH 534 are posted to the BOE's website at www.boe.ca.gov/proptaxes/ah534.htm.

The costs in this 2023 revision are based on recently sampled market data, Producer Price Index data, and cost information from knowledgeable sources in the rural cost field. Costs increased for the *Corrals and Fences*, *Greenhouses*, *Steel Buildings*, and *Miscellaneous Costs* chapters; and for some subcategories in the *Dairy Barns*, *Poultry Houses*, and *Pumps* chapters. No other changes were made to the other chapters and/or categories.

Statutory and regulatory considerations, general instructions, and pertinent information concerning the use of this handbook are contained in the *Costing Information* (AH 534.00) chapter. Comments appropriate to an improvement type are found in some of the introductory pages of the respective chapters of the handbook devoted to a particular improvement type.

Diligent efforts have been made to supply accurate and reliable information. AH 534 should serve as a guide, but it is important for the appraiser to research and analyze permit costs and fees of jurisdictions in the region and to make appropriate adjustments where necessary, due primarily to the wide variance in these costs, both within and among the counties. An appraiser must research the market to determine which costs are most applicable for the appraisal assignment when considering the data provided in AH 534, along with local cost data.

This revision was prepared by County-Assessed Properties Division staff under the direction of the Property Tax Department.

David Yeung
Deputy Director
Property Tax Department
California State Board of Equalization
December 2022

RURAL BUILDING COSTS

TABLE OF CONTENTS

<u>Chapter</u>		<u>Page</u>
534.00	<u>COSTING INFORMATION</u>	1
	STATUTORY AND REGULATORY BASIS	1
	BASIS OF COST	2
	GLOSSARY OF TERMS	3
534.10	<u>BASIC FARM BUILDINGS</u>	1
	PREFABRICATED HORSE BARNs	2
	STEEL FRAME RIDING ARENAS	3
	GENERAL PURPOSE BARNs	4
	HAY STORAGE BARNs	5
	FEED BARNs	6
	POLE BUILDINGS	7
	SHOPS	8
	MACHINERY AND EQUIPMENT SHEDs	10
	PREFABRICATED WOOD STORAGE SHEDs	12
	SMALL SHEDs	13
	PHOTOGRAPHS	14
534.20	<u>DAIRY BARNs</u>	1
	COMMONLY USED MILKING PARLORS	1
	MODERN HERRINGBONE, PARALLEL, OR ROTARY	1
	MILKING PARLOR	3
	HOLDING, WASH, AND DRIP AREA EQUIPMENT	3
	DAIRY EQUIPMENT	4
	FREESTALL BARN	6
	HOSPITAL BARN	6
	CORRALS	7
	COMMODITY BARNs	7
	HAY BARNs	7
	MISCELLANEOUS EQUIPMENT	8
	LIQUID MANURE SYSTEMs	10
	GRADE "B" BARNs	11
	STANCHION BARNs	12
	WALK THROUGH BARNs	13
	ILLUSTRATIONS AND PHOTOGRAPHS	14
534.30	<u>POULTRY HOUSEs</u>	1
	HOUSING-CONVENTIONAL LAYER HOUSEs	1
	HOUSING-BROILER HOUSEs	2
	HOUSING-BREEDER HOUSEs	2
	EQUIPMENT	3
	PHOTOGRAPHS	4
534.61	<u>IRRIGATION SYSTEMs</u>	1
	CONCRETE PIPE-INSTALLED	1
	PVC PIPE	3
	ALUMINUM PIPE	4

<u>Chapter</u>		<u>Page</u>
534.61 (cont.)	IRRIGATION VALVES	5
	PERMANENT IRRIGATION SYSTEMS	9
	CONCRETE DITCHES	12
	PHOTOGRAPHS	13
534.62	<u>PUMPS</u>	1
	SAN JOAQUIN VALLEY BASE TURBINE PUMPS	1
	DIESEL POWERED DEEP WELL IRRIGATION PUMPS	2
	SUBMERSIBLE PUMPS	5
	WELLS	6
	WINDMILLS	7
	PHOTOGRAPHS	10
534.71	<u>CORRALS AND FENCES</u>	1
	STEEL FENCING	1
	BARBED WIRE FENCING	2
	WOOD FENCING	2
	WOOD GATES	2
	METAL GATES	3
	METAL PANELS	4
	VINYL/PVC FENCING	5
	CATTLE SQUEEZE	6
PHOTOGRAPHS	7	
534.75	<u>GREENHOUSES</u>	1
	BUILDING SPECIFICATIONS	1
	SQUARE-FOOT COSTS	2
	SHADE CLOTH HOUSES	2
	PHOTOGRAPHS	3
534.76	<u>LAND DEVELOPMENT AND DRAINAGE TILE</u>	1
	LAND DEVELOPMENT	1
	DRAINAGE	2
534.77	<u>VINEYARD STAKES AND TRELLIS SYSTEMS</u>	1
	TABLE GRAPES—SINGLE CROSS-ARM	2
	TABLE GRAPES—DOUBLE CROSS-ARM	3
	TABLE GRAPES/RAISINS—OPEN GABLE TRELLIS	4
	RAISIN GRAPES TRELLIS	5
	RAISIN GRAPES—OVERHEAD DRY ON VINE TRELLIS	6
	WINE GRAPES TRELLIS	7
	WINE GRAPES LYRE SYSTEM	13
	MISCELLANEOUS	15
	USEFUL INFORMATION	16
PHOTOGRAPHS AND ILLUSTRATIONS	17	
534.78	<u>STEEL BUILDINGS</u>	1
	BASIC BUILDING COST	1
	COST PER SQUARE FOOT	2
	QUONSET-STYLE BUILDINGS	3
	ADDITIVE COSTS	4
	PHOTOGRAPHS	6

<u>Chapter</u>		<u>Page</u>
534.79	<u>MISCELLANEOUS COSTS</u>	1
	ELECTRONIC TRUCK SCALES WITH CONCRETE DECK	1
	ELEVATED HOPPER TANK	1
	CONCRETE HORIZONTAL OR FLAT STORAGE	2
	ABOVE-GROUND FUEL TANKS & CONTAINMENT SYSTEMS	2
	WATER TANKS	3
	STEEL GRAIN BINS	5
	REDWOOD WATER STORAGE TANKS	6
	STAINLESS STEEL WINE TANKS	8
	CYLINDRICAL 2 INCH OAK TANKS	8
	PREFABRICATED METAL SHADES	9
	PHOTOGRAPHS	10
534.80	<u>WIND MACHINES</u>	1
	NEW WIND MACHINES	1
	USED WIND MACHINES	2
	RECONDITIONED WIND MACHINES	3
	COLD AIR DRAIN	4
	GLOSSARY OF ABBREVIATIONS	5
	PHOTOGRAPHS	6
534.90	<u>DEPRECIATION</u>	1
	DEFINITIONS	1
	<i>Percent Good Tables</i>	1
	<i>Average Life Tables</i>	1
	<i>Remaining Life Expectancy Tables</i>	2
	<i>Extended Life Concept</i>	2
	EFFECTIVE YEAR	2
	<i>Physical Condition</i>	2
	AVERAGE LIFE TABLES	4
	NORMAL PERCENT GOOD TABLES	7

AH 534.00: COSTING INFORMATION

STATUTORY AND REGULATORY BASIS

Assessors' Handbook Section 534 (AH 534) was designed and developed for use by the 58 California counties as an aid to Assessors in fulfilling their statutory and regulatory requirement in the assessment of all taxable property in the county.¹

The work in AH 534 is guided by Property Tax Rule 6² and Revenue and Taxation Code section 401.5. Rule 6 provides in part:

(a) The reproduction or replacement cost approach to value is used in conjunction with other value approaches and is preferred when neither reliable sales data (including sales of fractional interests) nor reliable income data are available and when the income from the property is not so regulated as to make such cost irrelevant. It is particularly appropriate for construction work in progress and for other property that has experienced relatively little physical deterioration, is not misplaced, is neither over- nor underimproved, and is not affected by other forms of depreciation or obsolescence.

(b) The reproduction cost of a reproducible property may be estimated either by (1) adjusting the property's original cost for price level changes and for abnormalities, if any, or (2) applying current prices to the property's labor and material components, *with appropriate additions for entrepreneurial services*, interest on borrowed or owner-supplied funds, and other costs typically incurred in bringing the property to a finished state (or to a lesser state if unfinished on the lien date). Estimates made under (2) above may be made by using square-foot, cubic-foot, or other unit costs; a summation of the in-place costs of all components; a quantity survey of all material, labor, and other cost elements; or a combination of these methods. [Emphasis added.]

Section 401.5 reads as follows:

The board shall issue to assessors data relating to costs of property, or, with respect to commercial and industrial property, shall, after a public hearing, review and approve commercially available data, and shall issue to assessors other information as in the judgment of the board will promote uniformity in appraisal practices and in assessed values throughout the state. *An assessor shall adapt data received pursuant to this section to local conditions and may consider that data together with other factors as required by law in the assessment of property for tax purposes.* [Emphasis added.]

¹ Revenue and Taxation Code section 405.

² Title 18, Public Revenues, California Code of Regulations, section 6.

BASIS OF COST

Costs to construct improvements such as barns, greenhouses, steel buildings, etc., in this handbook are based on the cost to build on a level and cleared site in California as of the date in the lower right-hand corner of each page. The costs are contingent on the following assumptions:

- A clear site
- Normal soil conditions
- Adequate site drainage
- No off-site improvement cost

The costs in this handbook include normal expenses incurred in placing the improvement or component in the hands of the ultimate consumer, including the following:

1. Excavation for foundations, piers, and other structural foundation components, considering a level site
2. Materials
3. Labor
4. Architectural fees
5. Engineering fees
6. Supervision
7. Permits for improvements, land use, environmental impact, etc.
8. Normal utility hook-ups, if any
9. Contractor's overhead and profit
10. Contingencies
11. Carrying charges during construction
 - Taxes
 - Interest
 - Insurance
12. Legal expenses

All data are in the form of in-place costs for improvements and additives that may differ between various structures.

The costs in this handbook do not include entrepreneurial profit except where noted. It is, therefore, necessary for the appraiser to add an appropriate market adjustment for entrepreneurial profit where appropriate for real property improvements.

GLOSSARY OF TERMS

Term	Definition
A-Frame Cages	Cages stacked in an "A" formation which house chickens for the purpose of egg production.
Battery Cages	Vertically stacked cages which house chickens for the purpose of egg production.
Bent	A framework that is perpendicular to the length of a building.
Breeder	A chicken that produces eggs for the purpose of producing day-old chicks.
Breeder House	A structure which houses breeder chickens.
Broiler	A chicken farmed for retail food products.
Broiler House	A structure which houses broiler chickens.
Chime Joists	Wooden support members that are placed under the bottom of a redwood storage tank.
Cistern	An artificial reservoir or tank, often underground, which stores rain water collected from a roof.
Cordon	Shoots or canes originating from the crown of a grapevine that are trained along wire on trellis systems.
Crown	Termination of grapevine trunk where cordons emerge.
Cwt	A unit of weight measurement which is equal to 100 pounds.
Free-Stall Barn	A structure that contains individual stalls cows may enter, lie down, or leave without restriction.
Gable Roof	A ridged roof that slopes up from only two walls. A gable is the triangular portion of the end of a building from the eaves to the ridge.
Gas Brooder	A small, gas-fueled circular heater used to keep young chickens warm.

GLOSSARY OF TERMS

Gear Head	Housing enclosing gears used to provide positive power transmission to a pump.
Girts	A secondary horizontal framing member located between studs or columns. They are designed to stiffen the framing system and often provide support for siding or sheathing.
Grapevine Trunk	The main structural member that supports all upper growth of the grapevine that is supported by and is directly attached to the roots. The trunk develops from a single shoot that is selected from several that grow from the grape cutting in the first season of growth. This selected shoot is then trained up the stake to form the trunk.
Hopper	An elevated bin with a cone-shaped bottom. A gate at the bottom, when opened, allows the stored material to be emptied due to the sloping sides of the cone.
J-R Clip	A type of clip used on T-Posts to attach wires to trellis systems that are commonly used for vertical trellis systems.
Layer House	A structure which houses chickens for the purpose of egg production.
Loam	A rich soil composed of clay, sand, and organic matter. Generally, any rich, dark soil.
Mangers	A box or trough that holds animal feed.
Mudsills	The lowest sill of a structure. As a foundation, timber placed directly on the ground or foundation.
Nipple System	A system that uses mechanical nipples to provide fresh drinking water to chickens.
Pencil Rod	Metal stake of approximately 3/8" used to train new grapevines.
Pole Building	A structure whose main frame and foundation are treated posts or piles sunk into the ground with prefabricated trusses.
Polycarbonate	A class of resins that are used to produce tough, transparent items such as roof material and siding of greenhouses.

GLOSSARY OF TERMS

Polyethylene	A type of plastic with a wide array of applications. One common use is to insulate greenhouses.
Purlin	Horizontal structural members that support the common rafters in roofs.
Quonset Building	A prefabricated metal building with a curved roof that extends to the ground forming the sides of the building. Common uses are for storage of agricultural equipment or products such as baled hay.
Ripping	The term used in agriculture to indicate plowing or breaking up of soil. The result is a reduction in compacted soil.
Sash	The frame in which window lights are set.
Silage	A type of foodstuff for livestock prepared from green crops (for example, grass). The crops are stored in a pit or silo. The bacteria on the plants carry out fermentation resulting in the preservation of the plant material from further decay and loss of nutritional value.
Solid Set Irrigation	Irrigation system where the pipe may be left in place during the irrigation season.
Spurs	Pruned section (usually to two buds) of growth that originates from cordons that are last season's growth that will produce the following season's fruit and growth. Some spurs (non-fruiting) are also maintained to replace the cordons.
T-1-11	A registered trademark name for a common plywood siding. The 4' by 8' sheets have a distinctive rough texture on the exterior side with vertical grooves spaced regularly across the face.
Vertical Line Post	Used in vertical shoot positioning trellis systems. The built-in wire slots make it a good choice for mechanized harvesting.
Unloading Auger	A screw-like device that rotates, resulting in the horizontal movement of stored material out of a storage bin.
Wind Machines	Powered fans used to provide frost protection for crops. They are used when temperatures approach freezing and sufficient temperature inversion in the frost area makes warmer air available to either mix with or displace colder lower lying air.

AH 534.10: BASIC FARM BUILDINGS

Basic farm buildings and outbuildings vary depending on use and type of farm operation. This chapter covers many of the structures that may be used in agricultural farming and also contains specifications and costs of various buildings which include the following:

- Prefabricated horse barns
- Steel frame riding arenas
- General purpose barns
- Hay storage barns
- Feed barns
- Pole buildings
- Shops
- Machinery and equipment sheds
- Prefabricated wood storage sheds
- Small sheds

Photographs showing examples of the buildings discussed are located at the end of this chapter.

BASIC FARM BUILDINGS

PREFABRICATED HORSE BARN

Prefabricated barns have many benefits that make them desirable for horse accommodation. They are very strong and easier to build because they have fewer pieces to assemble than wood structures. They are more cost-effective than their wood counterparts, in part because they have most of the detail work already completed. The material used in prefabricated horse barns is generally not subject to problems such as warping, twisting, cracking, rotting, or deterioration. Prefabricated horse barns are also more resistant to damage from vermin and termites and are non-flammable, making them very safe. Property and fire insurance costs tend to be lower for prefabricated barns than for wood structures.

SPECIFICATIONS

Structure	6" steel purlins on 6' centers; enamel exterior
Foundation	Concrete piers
Floor	Dirt
Door	Sliding stall (inside track)
Roof	2" x 12" pitch; skylight in each stall
Roofing	White 26 gauge steel hi-rib
Walls	Laminated wall panels; grilled fronts; top 4'; 5" colored gutter trim

IN-LINE SHED ROW BARN

Stall Size	First Stall	Each Additional Stall
12' x 12'	\$5,892	\$5,291
12' x 16'	\$6,778	\$5,892

Shed roof overhang per square foot: 8' — **\$6.70**
12' — **\$7.48**

(Photographs shown on AH 534.10, pages 14 and 15)

BASIC FARM BUILDINGS

PREFABRICATED HORSE BARNs

GABLE ROOF BARN—STANDARD BREEZEWAY

Stall Size	First Two Stalls	Each Additional Two
12' x 12' with 12' breezeway	\$15,444	\$13,013
12' x 12' with 16' breezeway	\$16,016	\$13,085
12' x 16' with 12' breezeway	\$17,089	\$14,872
12' x 16' with 16' breezeway	\$17,661	\$15,730

GABLE ROOF BARN—RAISED BREEZEWAY

Stall Size	First Two Stalls	Each Additional Two
12' x 12' with 12' breezeway	\$16,231	\$14,014
12' x 12' with 16' breezeway	\$17,375	\$15,015
12' x 16' with 12' breezeway	\$18,519	\$16,517
12' x 16' with 16' breezeway	\$18,733	\$17,661

Roof extension per square foot—**\$7.80**

12-foot breezeway doors—**\$1,040** each

16-foot breezeway doors—**\$1,196** each

(Photographs shown on AH 534.10, pages 14-15)

ADDITIVES

Item	Cost
Concrete floor	\$6.24 - \$6.76 per square foot
Full footing	\$17.55 per linear foot
Portable 5' x 12' – 4 rail corral panels	\$10.73 - \$14.76 per linear foot
Portable 5' x 12' – 5 rail corral panels	\$12.03 - \$16.06 per linear foot
Portable 6' rail corral panels with metal roof	\$7.48 - \$8.97 per square foot

STEEL FRAME RIDING ARENA

Frame	Good quality steel frame, 14' to 16' eave height
Roof	Gable roof with 26-gauge panels
Walls	None
Floor	Sand
Plumbing	Minimum water outlets
Electrical	None—or add \$0.88 to \$1.47 per square foot
Cost	\$14.73 to \$16.59 per square foot
Add for vinyl fencing	\$11.80 to \$17.67 per linear foot

(Photographs shown on AH 534.10, page 16)

BASIC FARM BUILDINGS

GENERAL PURPOSE BARNs

General purpose barns are usually the center of a farming operation. They can be used to house animals, provide refuge for animals in poor weather, store food and equipment, or provide indoor working areas. Areas within a barn can be constructed with stalls, grooming areas, tack rooms, or storage rooms for supplies. Other possible uses include areas for birthing, sheering, milking, or equipment maintenance.

BUILDING SPECIFICATIONS

Components	Class 1 Fair Quality	Class 2 Average Quality	Class 3 Good Quality
Foundation	Redwood or cedar mudsills	Concrete or masonry piers	Continuous concrete
Floor	Dirt	Dirt/some concrete	Concrete
Wall Structure	Light wood frame, 10' eave height	Average wood frame, 10' eave height	Good wood frame, 10' eave height
Roof Construction	Medium to high pitch—2" x 4" rafters, 24" to 36" on center, or light wood trusses	Medium to high pitch—average wood trusses	Medium to high pitch—good wood trusses
Roof Cover	Light aluminum	Standard gauge corrugated iron or aluminum	26-gauge steel
Electrical	None	Two outlets per 1,000 square feet	Four outlets per 1,000 square feet
Plumbing	None	One cold water outlet	Two cold water outlets

(Photographs shown on AH 534.10, pages 17, 18, and 19)

SQUARE-FOOT COSTS

Class	Square-Foot Area					
	1,000	3,000	5,000	7,000	9,000	11,000
1	\$23.60	\$18.24	\$16.87	\$16.24	\$15.59	\$15.30
2	\$31.40	\$25.53	\$23.82	\$22.88	\$22.39	\$21.59
3	\$47.41	\$38.90	\$35.89	\$34.61	\$33.49	\$32.62

BASIC FARM BUILDINGS

HAY STORAGE BARNs

Outbuildings for most farms with animals typically include a hay barn. It is important to have a separate building for hay because hay may spontaneously combust endangering livestock. A separate grain room or supplemental feeding area is also important within the hay barn.

BUILDING SPECIFICATIONS

Components	Class 1 Fair Quality	Class 2 Average Quality	Class 3 Good Quality
Foundation	Redwood or cedar mudsills	Concrete or masonry piers	Continuous concrete
Floor	Dirt	Dirt	Concrete
Wall Structure	Light wood frame, 20' eave height	Average wood frame, 20' eave height	Good wood frame, 20' eave height
Exterior Wall Cover	Light aluminum or low cost boards	Standard gauge corrugated iron or aluminum	Good wood siding, painted or 26-gauge steel
Roof Construction	Medium to high pitch—2" x 4" rafters, 24" to 36" on center, or light wood trusses	Medium to high pitch—average wood trusses	Medium to high pitch—good wood trusses
Roof Cover	Light aluminum	Standard gauge corrugated iron or aluminum	26-gauge steel
Electrical	None	Two outlets per 1,000 square feet	Four outlets per 1,000 square feet
Plumbing	None	One cold water outlet	Two cold water outlets
Shape	Nearly square, length between one and two times width	Nearly square, length between one and two times width	Nearly square, length between one and two times width

(Photographs shown on AH 534.10, page 20)

SQUARE-FOOT COSTS

Class	Square-Foot Area					
	1,000	3,000	5,000	7,000	9,000	11,000
1	\$18.30	\$15.38	\$14.01	\$12.87	\$12.44	\$11.80
2	\$21.24	\$17.45	\$15.87	\$14.87	\$14.16	\$13.66
3	\$34.61	\$28.74	\$26.53	\$24.31	\$23.17	\$22.24

Adjustments: Pole Buildings – Deduct 10 percent from above costs
 No Electricity/No Water – Deduct **\$0.98** to **\$1.30** per square foot

BASIC FARM BUILDINGS

FEED BARN

Feed barns are designed for livestock shelter and feeding. They are typically open on all sides but may be enclosed on the ends. A center aisle is used to transport feed to the feeders, which are usually located on both sides of the center aisle. The barns can be built using either wood posts or steel frames with a pitched roof of steel or aluminum.

BUILDING SPECIFICATIONS

Components	Class 1 Fair Quality	Class 2 Average Quality	Class 3 Good Quality
Foundation	Redwood or cedar mudsills	Concrete or masonry piers	Continuous concrete
Floor	Dirt	Concrete in center section	Concrete
Wall Structure	Light wood frame, 8' eave height at drip line	Average wood frame, 8' eave height at drip line	Good wood frame, 8' eave height at drip line
Exterior Wall Cover	Open sides and ends	Open sides, standard gauge corrugated iron, aluminum, or average wood siding on ends	Open sides, good siding painted on ends
Roof Construction	Medium to high pitch—light wood trusses	Medium to low pitch—average wood trusses	Medium to low pitch—good wood trusses
Roof Cover	Light aluminum	Standard gauge corrugated iron or aluminum	26-gauge steel
Electrical	None	Two outlets per 1,000 square feet	Four outlets per 1,000 square feet
Plumbing	None	One cold water outlet	Two cold water outlets

(Photographs shown on AH 534.10, page 21)

SQUARE-FOOT COSTS

Class	Square-Foot Area					
	1,000	3,000	5,000	7,000	9,000	11,000
1	\$12.38	\$11.15	\$10.58	\$10.37	\$10.30	\$10.09
2	\$19.59	\$17.95	\$17.38	\$17.10	\$16.95	\$16.81
3	\$23.60	\$21.78	\$21.24	\$20.74	\$20.53	\$20.45

BASIC FARM BUILDINGS

POLE BUILDINGS

A pole building is basically a series of upright poles supporting a roof. These buildings are generally rectangular with a gabled roof. The poles make up the outside perimeter of the barn, and often have no outside walls. Storage of goods like hay or livestock is the main purpose of these structures. The major advantages of pole barns over other agricultural storage building options are their low cost and easy accessibility for storage.

BUILDING SPECIFICATIONS

Structure	Poles: 15' to 20' on center; wood or steel
Floor	Dirt
Roof	Light trusses; low to medium pitch; wood or steel
Roofing	Galvanized steel or colored steel with gutter
Walls	None, wall height: 18' - 21' to plate

(Photographs shown on AH 534.10, page 22)

SQUARE-FOOT COSTS

ALL SIDES OPEN

GOOD QUALITY

End Width	Side Length									
	30	50	80	100	120	140	150	160	180	200
20	\$11.23	\$10.95	\$10.73	\$10.52	\$10.37	\$10.15	\$10.09	\$9.95	\$9.87	\$9.80
30	\$10.73	\$10.52	\$10.30	\$10.09	\$9.87	\$9.80	\$9.72	\$9.58	\$9.52	\$9.44
40	\$10.31	\$10.15	\$9.87	\$9.72	\$9.66	\$9.37	\$9.30	\$9.23	\$9.15	\$9.09
50	\$9.87	\$9.72	\$9.52	\$9.37	\$9.30	\$9.01	\$8.94	\$8.87	\$8.72	\$8.66
60	\$9.52	\$9.37	\$9.15	\$9.01	\$8.94	\$8.66	\$8.52	\$8.44	\$8.37	\$8.29
70	\$9.15	\$9.01	\$8.80	\$8.58	\$8.52	\$8.23	\$8.15	\$8.09	\$8.01	\$7.94
80	\$8.80	\$8.66	\$8.44	\$8.23	\$8.15	\$7.94	\$7.87	\$7.80	\$7.72	\$7.66

Deduct 15 percent for light duty, fair quality construction.

Skylights (3' x 10') **\$109 - \$137** each

Vents (14", Rotary) **\$267** each

Poles, In-Place **\$225 to \$308** each

Covered wall area add **\$5.14** per square foot of wall surface

Reinforced Concrete Floors:

4" **\$6.70** per square foot

6" **\$7.48** per square foot

BASIC FARM BUILDINGS

SHOPS

Shops provide a center for repair and maintenance of machines and equipment. They are a place for orderly tool storage, supply and spare part storage, and shelter when work cannot be done outside. Workshops are usually present on most farms. Size and design should complement the type of farm and the work to be done.

BUILDING SPECIFICATIONS

Components	Class 1 Fair Quality	Class 2 Average Quality	Class 3 Good Quality
Foundation	Light concrete	Light concrete	Standard concrete
Floor	3" concrete	4" concrete	4" reinforced concrete
Wall Structure	Light wood frame, 15' eave height	Average wood frame, 15' eave height	Good wood frame, insulated, 15' eave height
Exterior Wall Cover	Light aluminum or low cost boards	Standard gauge corrugated iron, aluminum, or average wood siding	Good wood siding painted or 26-gauge steel
Roof Construction	Low to medium pitch— 2" x 4" rafters, 24" to 36" on center, or light wood trusses	Low to medium pitch— average wood trusses	Medium pitch— good wood trusses, insulated roof
Roof Cover	Light aluminum corrugated	Standard gauge corrugated iron or aluminum	26-gauge steel, with skylights
Electrical	Two outlets per 1,000 square feet	Two outlets per 1,000 square feet	Excellent lighting and ample outlets
Plumbing	None	One cold water outlet	Two cold water outlets
Doors	One light sliding or swinging door per 2,000 square feet	One average sliding or swinging door per 2,000 square feet	One drive-thru door per 1,000 square feet plus one walk-thru door
Windows	None	None or few low cost	5 percent of floor area
Shape	Nearly square, length between one to three times width	Nearly square, length between one to three times width	Nearly square, length between one to three times width

(Photographs shown on AH 534.10, page 23)

BASIC FARM BUILDINGS

SHOPS

SQUARE-FOOT COSTS

Class	Square-Foot Area									
	1,000	1,500	2,000	2,500	3,000	4,000	5,000	6,000	8,000	10,000
1	\$27.39	\$25.03	\$23.53	\$22.31	\$21.31	\$20.88	\$20.16	\$19.16	\$19.10	\$18.59
2	\$34.18	\$31.25	\$29.46	\$28.46	\$27.39	\$26.17	\$25.03	\$24.60	\$24.02	\$23.45
3	\$39.55	\$38.61	\$37.40	\$35.75	\$34.26	\$33.25	\$32.18	\$31.03	\$30.03	\$28.89

BASIC FARM BUILDINGS

MACHINERY AND EQUIPMENT SHEDS

It is important to have a building to store machinery, tools, and farm vehicles, such as tractors and their attachments, for protection from the elements. Smaller pieces of equipment also need a place to be stored during poor weather. In some instances, these buildings are enclosed to prevent theft and vandalism, but most are open to provide easy access.

BUILDING SPECIFICATIONS

Components	Class 1 Fair Quality	Class 2 Average Quality	Class 3 Good Quality
Foundation	Redwood or cedar mudsills	Concrete or masonry piers	Continuous concrete
Floor	Dirt	Concrete	Concrete
Wall Structure	Light wood frame, 10' to 12' eave height	Average wood frame, 10' to 12' eave height	Good wood frame, 10' to 12' eave height
Exterior Wall Cover	Light aluminum or low cost boards	Standard gauge corrugated iron or aluminum	Good wood siding, painted or 26-gauge steel
Roof Construction	Low to medium pitch—shed type, light wood framing	Low to medium pitch—gable or shed type, average wood framing	Low to medium pitch—gable or shed type, good wood framing
Roof Cover	Light aluminum	Standard gauge corrugated iron or aluminum	26-gauge steel, with skylights
Electrical	None	Two outlets per 1,000 square feet	Four outlets per 1,000 square feet
Shape	Usually elongated, width between 20 and 40 feet, any length	Usually elongated, width between 20 and 40 feet, any length	Usually elongated, width between 20 and 40 feet, any length

(Photographs shown on AH 534.10, page 24)

BASIC FARM BUILDINGS

MACHINERY AND EQUIPMENT SHEDS

SQUARE-FOOT COSTS—TYPE I, ALL SIDES CLOSED

Class	Square-Foot Area										
	500	1,000	1,500	2,000	2,500	3,000	3,500	4,000	4,500	5,000	6,000
1	\$16.52	\$14.87	\$13.87	\$13.38	\$13.16	\$12.95	\$12.87	\$12.81	\$12.66	\$12.52	\$12.30
2	\$24.39	\$21.31	\$20.10	\$19.73	\$19.31	\$19.16	\$18.95	\$18.67	\$18.53	\$18.38	\$17.88
3	\$31.54	\$28.46	\$26.46	\$26.03	\$25.39	\$25.25	\$24.96	\$24.74	\$24.60	\$24.45	\$24.02

SQUARE-FOOT COSTS—TYPE II, ONE SIDE OPEN

Class	Square-Foot Area										
	500	1,000	1,500	2,000	2,500	3,000	3,500	4,000	4,500	5,000	6,000
1	\$14.59	\$12.23	\$11.52	\$11.15	\$10.95	\$10.73	\$10.58	\$10.52	\$10.44	\$10.37	\$10.30
2	\$22.31	\$19.16	\$17.67	\$17.10	\$16.59	\$16.45	\$16.30	\$16.24	\$16.02	\$15.81	\$15.73
3	\$29.11	\$27.25	\$26.31	\$25.25	\$24.53	\$24.17	\$23.96	\$23.74	\$23.67	\$23.45	\$23.39

Pole Buildings – Deduct 15 to 20 percent from above costs.

BASIC FARM BUILDINGS

PREFABRICATED WOOD STORAGE SHEDS

Prefabricated wood storage sheds are normally purchased at lumber yards and home improvement centers. They are commonly used to house small machinery and equipment.

BUILDING SPECIFICATIONS

Foundation	4" x 4" pressure treated skids
Floor	Plywood or particleboard on 2" x 6" floor joists
Walls Structure	2" x 4" framing on 24" centers, 7' to 8' eave height
Exterior Wall Cover	Plywood or T-1-11 with one 4' x 6' door
Roof	Gable low to medium pitch, 2" x 4" rafters
Roof Cover	Metal or composition shingles

(Photographs shown on AH 534.10, page 25)

SQUARE-FOOT COSTS

Square Feet	Price Per Square Foot
50 to 74	\$25.57
75 to 99	\$24.99
100 to 139	\$20.42
140 to 199	\$18.53
200 and up	\$17.20 - \$21.98

ADDITIVES

Windows	2' x 2'	\$182 each
	3' x 2'	\$221 each
Doors—Double 6' Wide		\$202
Skylight—2' x 2'		\$221
Turbine Vent		\$117
Shelves—16" wide		\$5.72 per linear foot
Shelves—24" wide		\$7.02 per linear foot
Workbench—24" wide		\$8.39 per linear foot
Steel roll-up door		\$100 per foot (width)
Loft		\$4.03 per square foot
Extra Concrete		\$7.35 - \$8.84 per square foot

BASIC FARM BUILDINGS

SMALL SHEDS

BUILDING SPECIFICATIONS

Components	Class 1 Fair Quality	Class 2 Average Quality	Class 3 Good Quality
Foundation	Redwood or cedar mudsills	Concrete or masonry piers	Continuous concrete
Floor	Dirt	Boards	Concrete
Wall Structure	Light wood frame, 8' eave height	Average wood frame, 8' eave height	Good wood frame, 8' eave height
Exterior Wall Cover	Light aluminum or low cost boards	Standard gauge corrugated iron or aluminum, or average framing	Good wood siding, painted, or steel
Roof Construction	Low to medium pitch—shed type, light wood framing	Low to medium pitch—gable or shed type, average wood framing	Low to medium pitch—gable or shed type, good wood framing
Roof Cover	Light aluminum	Standard gauge corrugated iron or aluminum	Good steel cover; composition shingles
Electrical	None	None	None
Shape	Usually elongated, width between 6 and 12 feet, any length	Usually elongated, width between 6 and 12 feet, any length	Usually elongated, width between 6 and 12 feet, any length

SQUARE-FOOT COSTS—TYPE I, ALL SIDES CLOSED

Class	Square-Foot Area										
	50	60	80	100	120	150	200	250	300	400	500
1	\$26.00	\$23.60	\$21.00	\$17.94	\$17.29	\$16.06	\$15.54	\$14.95	\$14.11	\$13.65	\$13.07
2	\$36.53	\$32.96	\$29.77	\$27.43	\$26.13	\$24.77	\$23.73	\$22.36	\$21.00	\$20.41	\$19.96
3	\$44.92	\$40.37	\$38.48	\$36.01	\$33.48	\$30.81	\$29.12	\$28.02	\$26.65	\$26.13	\$25.48

SQUARE-FOOT COSTS—TYPE II, ONE SIDE OPEN

Class	Square-Foot Area										
	50	60	80	100	120	150	200	250	300	400	500
1	\$18.20	\$16.45	\$14.76	\$12.61	\$12.09	\$11.25	\$10.86	\$10.47	\$9.88	\$9.56	\$9.10
2	\$25.68	\$23.01	\$20.80	\$19.18	\$18.20	\$17.42	\$16.58	\$15.67	\$14.76	\$14.30	\$13.91
3	\$31.46	\$28.28	\$26.91	\$25.16	\$23.47	\$21.65	\$20.35	\$19.57	\$18.59	\$18.20	\$17.81

BASIC FARM BUILDINGS

PREFABRICATED HORSE BARNS



SHED ROW WITH 8 FOOT ROOF EXTENSION



GABLE ROOF WITH RAISED BREEZEWAY

BASIC FARM BUILDINGS

PREFABRICATED HORSE BARN



GABLE ROOF—RAISED BREEZEWAY WITH ROOF EXTENSION



12' X 12' STALL

BASIC FARM BUILDINGS

STEEL FRAME RIDING ARENA



BASIC FARM BUILDINGS

GENERAL PURPOSE BARN



BASIC FARM BUILDINGS

GENERAL PURPOSE BARN



BASIC FARM BUILDINGS

GENERAL PURPOSE BARN

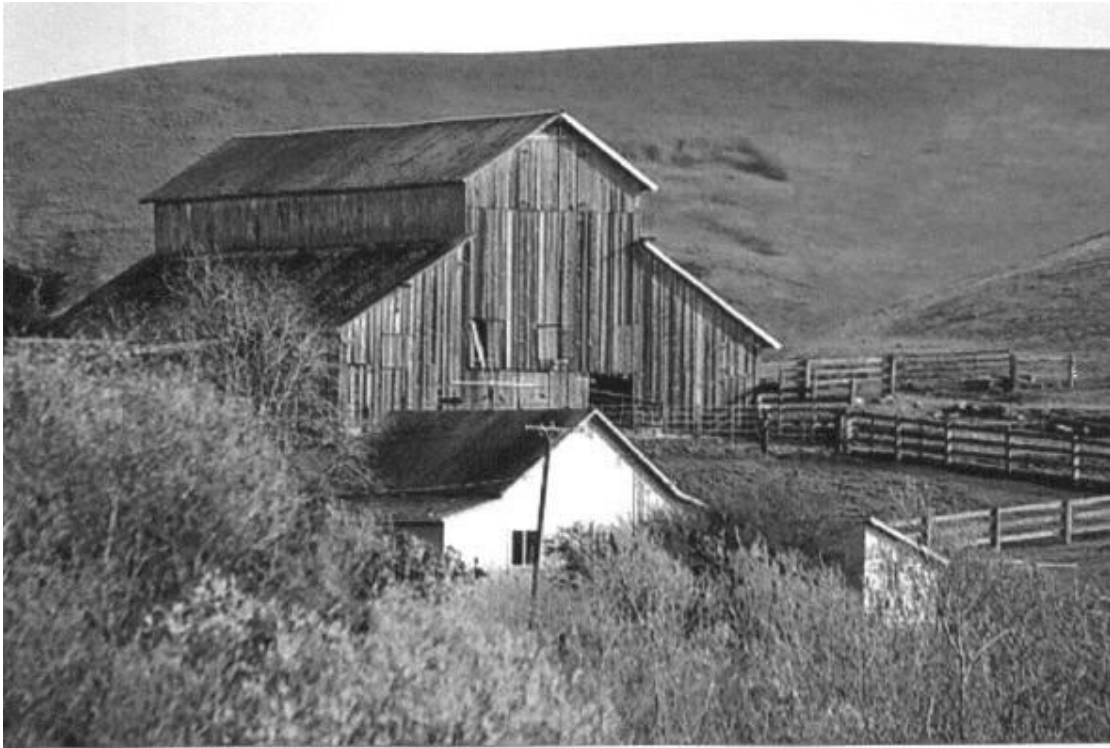

BASIC FARM BUILDINGS

HAY STORAGE BARN



BASIC FARM BUILDINGS

FEED BARN

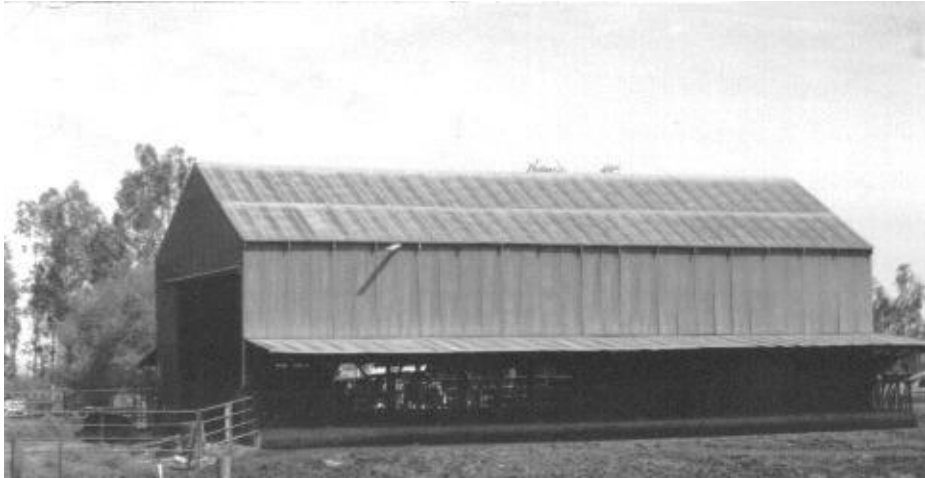
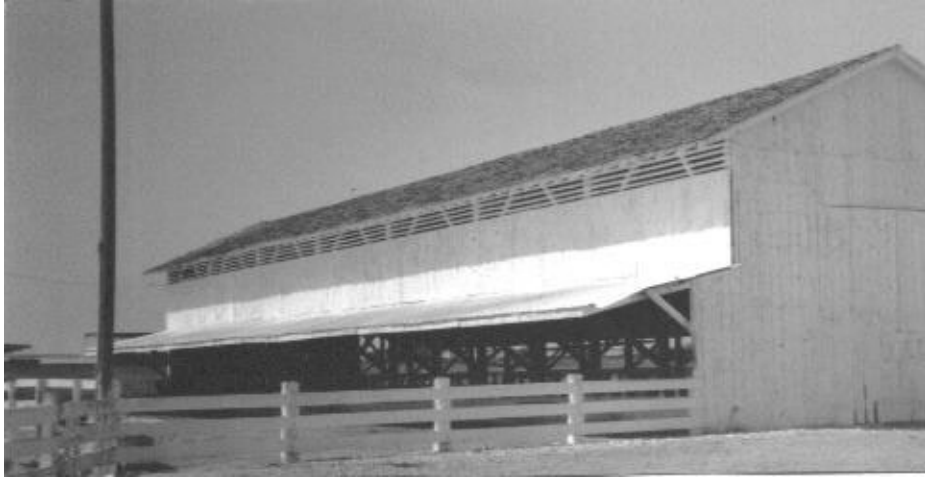

BASIC FARM BUILDINGS

POLE BUILDINGS



BASIC FARM BUILDINGS

SHOPS



BASIC FARM BUILDINGS

MACHINERY AND EQUIPMENT SHEDS

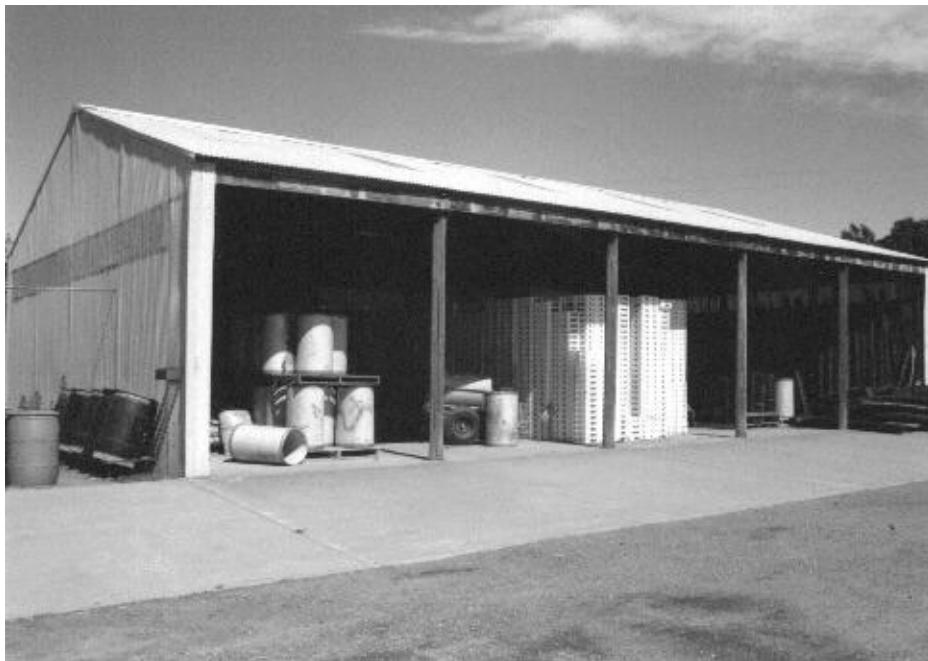

BASIC FARM BUILDINGS

PREFABRICATED WOOD STORAGE SHEDS



AH 534.20: DAIRY BARNS

This chapter contains structures and equipment typically used at a dairy. Specifications and costs are provided for the following:

- Commonly used milking parlors
- Modern Herringbone barns
- Parallel barns
- Rotary barns
- Milking parlor
- Holding, wash, and drip area equipment
- Dairy equipment
- Freestall barn
- Hospital barn
- Corrals
- Commodity barns
- Hay barns
- Miscellaneous equipment
- Septic tanks
- Barn fans
- Feedlane stanchions with curb
- Silage pits
- Liquid manure systems
- Painted steel bulk feed tanks on concrete pad/with hopper bottom
- Grade "B" barns
- Stanchion barns
- Walk-through type barns

Photographs or drawings showing examples of the buildings discussed are located at the end of the chapter.

DAIRY BARNS

COMMONLY USED MILKING PARLORS

Three of the most common styles of milking barns found in California are referred to as the Herringbone, the Polygon, or the Parallel because of their design. The type most frequently found is the Herringbone or sawtooth design, which also has several variations. For instance, the Polygon design is a parlor using multiple sets of Herringbone stalls. The Parallel design is gaining in popularity, especially in larger parlors. All three of these parlors have a central pit for the milker, with the cows elevated on one or all sides. An additional type is the Rotary parlor.

(Drawings with descriptions shown on AH 534.20, pages 14 - 16)

MODERN HERRINGBONE, PARALLEL, OR ROTARY

The high end of the cost range is for Sacramento and Northern California.

The major electrical components to run the milking equipment—mains and subpanels, breakers, and master start switches—are considered fixtures and are not included in building costs.

EQUIPMENT ROOM, OFFICE, BREEZEWAY, MILK ROOM, RESTROOM, BATH

Components	Average Quality	Good Quality
Foundation	Reinforced concrete	Reinforced concrete
Floors	Concrete slab	Concrete slab, reinforced
Walls	8" concrete block	Concrete block
Exterior	Stucco or concrete block	Stucco and masonry veneer, split face
Roof Structure and Roofing	Average wood frame, corrugated iron roofing	Good wood frame, good quality roofing or steel beams and good steel roofing or tile, skylights, gutters
Windows	Metal sash, 10 percent of wall area	Metal sash, 10 percent of wall area
Interior	Smooth finish plaster—cove base	Tile floors and walls, many areas
Electrical	Conduit—average fixtures	Conduit—excellent lighting and ample outlets
Plumbing	One stainless steel sink, one water heater, one lavatory, one water closet, usual floor drains	One stainless steel sink, one water heater, ¾ bath, vinyl floor and tape, textured walls, usual floor drains
Square-Foot Cost	\$86.04 to \$98.74 per square foot	\$98.74 to \$108.54 per square foot

(Drawings and photographs shown on AH 534.20, pages 15 – 20)

DAIRY BARNs

MILKING PARLOR

Foundation	6" reinforced concrete
Floors	Concrete slab—well-formed gutters and mangers
Walls	6" or 8" concrete block or reinforced concrete 60" high with 2" x 6"—16" on center framing above, or all concrete block
Roof Structure and Roofing	Average wood frame, corrugated iron roofing or steel beams, good steel roofing, skylights
Windows	Metal sash or metal louvers
Interior	Smooth plaster on entire surface of block walls or some combination of tile and plaster of good quality
Electrical	Conduit—average fixtures; ample lighting
Plumbing	Usual floor drains and hose bibs
Square-Foot Cost	Without gates and feeding equipment—\$57.36 to \$71.88 per square foot

Total Building Cost: includes equipment room, milk room, office, bath, supply, milking parlor, and wash and drip area—Average quality **\$61.38 to \$77.22** per square foot
 Good quality **\$79.20 to \$85.80** per square foot

HOLDING, WASH, AND DRIP AREA EQUIPMENT

Floor or Ramp	Sloping concrete with carborundum finish. \$5.02 - \$5.81 per square foot
Walls	Concrete block 5' to 6' high with smooth plaster. \$62.04 to \$68.64 per linear foot
Metal Rail Fence	Welded pipe 7'—10' o.c. in concrete. \$15.84 - \$18.48 per linear foot
Cable Fence	1 1/4" top rail, 2 7/8" post, 7' o.c. 3 cable— \$12.28 to \$13.33 per linear foot 4 cable— \$13.73 to \$15.18 per linear foot
Gates	54" high, pipe with bracing. \$20.59 per linear foot of gate width
Sprinkler System	Hooded sprinkler, including pump. \$208 - \$252 per sprinkler, or per double 30 barn—60 cows \$26,038 - \$29,272
Roof Structure and Roofing	Average quality: Pipe supports, wood or light steel frame and corrugated iron roofing— \$7.13 to \$10.82 per square foot Good quality: Box beam columns, hot-dip galvanized and box beam galvanized rafters and purlins; quality steel roofing with skylights and electric lighting— \$11.75 to \$13.73 per square foot
Total Area Cost Including All Components	\$29.30 - \$35.24 per square foot

(Photograph shown on AH 534.20, page 21)

DAIRY BARNs

DAIRY EQUIPMENT

PARALLEL STALLS (DOUBLE 30)

2' x 30' parallel stall package includes galvanized reels, reel support post, sequencing panels, galvanized rump rail assembly, kick bar support, entrance gate, and hardware. 2' x 30' parallel drive kit includes air controls, air tubing, rump panels, drive guards, air cylinders, hardware, stainless steel curbing, and top rail. Air operated catch lane gates include air control ram, hardware to mount, step ladders with hand rails (front), and miscellaneous hardware.	\$133,826
--	-----------

VACUUM PUMP

Air vacuum pump with 30 HP motor, stand, pulleys, belts, guards, filter assembly, miscellaneous pipe valves, and electrical.	\$14,399
--	----------

PIPELINE AND EQUIPMENT

Claws with pulsators and pulsator controller, master control panel, 2 HP milk pump, milk receiver, jetter assembly and hose, fresh air kit, clean-in-place sink. Also includes all stainless steel pipelines, elbows, valves, all PVC lines, electrical wiring and panels, and miscellaneous hardware.	\$117,007
--	-----------

MILK TRANSFER SYSTEM

Control assembly and miscellaneous equipment.	\$6,171
---	---------

DETACHERS

Air operated retraction with both manual and automatic operation, indicator lights indicating milking mode and milk flow, air operated shutoff valve/sensor combination, all related electric wiring, air filter, and hardware.	\$101,640
---	-----------

MILK TANKS (7,000 GALLON)

2 stainless steel 7,000-gallon tanks with agitators and wash pumps. Includes control panel, calibration gauge, temperature recorder with probe assembly, hot milk alarm, miscellaneous piping, and electrical.	\$144,958
--	-----------

REFRIGERATION SYSTEM

Freon compressor, air condensers, related hardware, pipes, valves, and electrical. Plate cooler with 100 plates and all hardware.	\$65,461
---	----------

Above costs include tax and labor

DAIRY BARNS

DAIRY EQUIPMENT

HEAT RECOVERY SYSTEM

Heat recovery system and all hardware.	\$14,520
--	----------

HOT WATER SYSTEM

Boiler with insulated 500-gallon storage tank, insulated piping, and electrical.	\$20,449
--	----------

SPRINKLER PEN HARDWARE

Pumps, sprinklers, and all related pipelines and miscellaneous hardware.	\$27,588
--	----------

AIR COMPRESSOR

10 HP air compressor with 120-gallon tank. Includes miscellaneous hardware and electrical.	\$10,890
--	----------

ELECTRIC OR AIR CROWD GATE

30 to 50 foot electric gate with track and control kit, motor, panel, and electrical.	\$29,403
---	----------

Above costs include tax and labor

EQUIPMENT ONLY (Including tax and labor)

Double 14' Parallel	Total - \$387,563 to \$406,802
Double 16' Parallel	Total - \$427,130 to \$444,917
Double 18' Parallel	Total - \$457,622 to \$508,442
Double 24' Herringbone	Total - \$559,383 to \$603,790
Double 25' Parallel	Total - \$578,380 to \$610,203
Double 30' Parallel	Total - \$635,613 to \$692,846
50-Cow Rotary Barn	Total - \$775,489 to \$889,834
70-Cow Rotary Barn	Total - \$1,080,893 to \$1,243,033

DAIRY BARNS

FREESTALL BARN

WITH STANCHIONS, LOOPS, AND FENCES

Foundation	Reinforced concrete
Floors	Sloping concrete with dirt in loop areas. Concrete drive lanes and flush areas.
Walls	Open; poles with steel supports
Roof Structure	Steel frame with steel cover; good quality, with gutters
Electrical	Minimum lighting
Plumbing	Water troughs in each pen with underground flushing
Stanchions	Steel; self-locking – 5 hole per 10 feet
Fencing	Cable with steel or wood posts
Capacity	250 to 600 cows; one stanchion per cow
Cost	\$1,137 to \$1,452 per stanchion or \$11.37 to \$14.52 per square foot

Some barns now have 10 percent more stanchions and cows than beds.

Hot dipped galvanized steel framed barns – add 5 percent to above costs.

Cow water beds – **\$174 to \$213** each

(Photographs shown on AH 534.20, page 22)

HOSPITAL BARN

AVERAGE QUALITY

Floors	Concrete slab with flush curbs
Walls	Light steel poles, all sides open
Roof	Average wood frame or light metal, with metal cover
Interior	Several small pens with metal pipe fencing and gates and water troughs
Electrical	Average light fixtures
Plumbing	Concrete water troughs
Cost	\$9.20 to \$9.92 per square foot

Hospital barns without small divided pens, with dirt floors, low to average quality: **\$5.67 to \$6.82** per square foot

(Photograph shown on AH 534.20, page 23)

DAIRY BARNS

CORRALS

Components	Cost
Concrete Flatwork Large areas/not reinforced	4" to 4½"— \$2.58 to \$3.00 per square foot 6"— \$3.12 to \$3.78 per square foot
Rubber Belting	\$ 2.50 to \$3.74 per square foot
Curbs	8" x 16"— \$9.12 per linear foot 8" x 24"— \$10.68 per linear foot
Cable Fence	2 3/8" top rail, 2 7/8" post—10' o.c. 3 cable— \$12.41 to \$13.20 per linear foot 4 cable— \$13.27 to \$14.92 per linear foot
Concrete Water Tank	\$708 to \$780 each
Steel Stanchions Without Stanchion Curb	\$55.80 to \$62.28 each hole \$30.36 to \$34.56 per linear foot
Steel Self-Locking Stanchions Without Stanchion Curb	\$59.28 to \$64.32 each hole \$29.04 to \$32.76 per linear foot
12" PVC Flush Line	\$14.28 to \$16.20 per foot
Sump Pumps	3 HP \$3,516 to \$3,762 5 HP \$4,734 to \$4,992
Floating Agitator Pump	75 HP \$22,710 to \$25,428 40 HP \$17,520 to \$18,816
Gates	12' to 16'— \$244.20 to \$303.60 each
Loafing Sheds	Wood— \$5.46 to \$6.96 per square foot Steel— \$6.48 to \$8.28 per square foot

COMMODITY BARNS

	Per Square Foot
With Dividers	\$14.08 - \$20.96
Without Dividers	\$12.16 - \$16.34

(Photograph shown on AH 534.20, page 23)

COMMODITY BARN ADDITIVES

Concrete Dividers—8' high 6" thick	\$131.00 per linear foot or \$16.40 per square foot
------------------------------------	---

HAY BARNS

Floors	Dirt
Walls	Open; used oil field pipe to support roof
Roof	20' eave; low pitch; light wood or steel frame; metal cover
Electrical	None
Plumbing	None
Cost	\$4.13 to \$5.12 per square foot

(Photograph shown on AH 534.20, page 24)

DAIRY BARNs

MISCELLANEOUS EQUIPMENT

CURBS

	Per Linear Foot
8" x 8"	\$4.48 to \$5.87
8" x 16"	\$8.98 to \$10.23
8" x 20"	\$10.23

CABLE FENCE

	Per Linear Foot
2 3/8" top rail with 2 7/8" post 10' o.c.	3 cable—\$12.32 to \$13.05 4 cable—\$13.05 to \$14.38 5 cable—\$13.71 to \$15.11
Cattle guard	\$1,766 to \$2,542 each

SOLID RAIL FENCE

	Per Linear Foot
(4) 2 3/8" rails with 2 7/8" post 10' o.c.	\$16.91 to \$19.16

TANKER PAD

	Per Square Foot
6" to 7" rebar reinforced concrete with footings	\$3.58 to \$4.18

WATER TROUGHS

Concrete water troughs - 2' x 12'	\$554 to \$575
Concrete water troughs - 2' x 16'	\$611 to \$745
Mineral troughs - 20'	\$206 to \$242

CORRAL SHADES

	Per Square Foot
Pipe poles, wood frame, metal cover	\$2.73 to \$3.03
Pipe poles, steel frame, metal cover	\$3.03 to \$3.70

WATER LINES

2" Water line	\$2.90 per linear foot
3" Water line	\$3.27 per linear foot
12" Flush line	\$15.73 per linear foot
18" Drain line	\$27.41 per linear foot
Flush valves	\$1,960 each
Drain boxes	\$2,093 each

DAIRY BARNs

SEPTIC TANKS

1,000 – 1,500 gallon with lines	\$4,997 to \$5,710
Cistern - per gallon	\$0.89 to \$0.95

BARN FANS

With misters and automatic controls	\$997 to \$1,288 each—installed
-------------------------------------	---------------------------------

FEEDLANE STANCHIONS WITH CURB

<p>Galvanized stanchions, 5-hole/10' Cow-type self-locking with release with 2 7/8" post in 8" x 16" concrete curb</p> <p>Cost Per Linear Foot: \$44.75 to \$46.86, stanchion and curb only</p> <p>Additional concrete Drivelane 6" reinforced - \$3.43 to \$4.16 per sq. ft. Walklane 4" concrete - \$2.84 to \$3.17 per sq. ft. Flush curb 8" x 8" - \$5.41 per linear foot</p>	
Cow lane 12' wide with locking stanchions and stanchion curb and 10' feed lane	\$114.18 to \$116.95 per linear foot

(Photograph shown on AH 534.20, page 25)

SILAGE PITS

Tilt-up of 6" concrete or 8" reinforced concrete block, 8' high, and enclosed on three sides with 6" concrete slabs.

<u>Size</u>	<u>Cost Per Square Foot</u>
75 x 100	\$7.92
100 x 200	\$6.60
100 x 300	\$6.28

Concrete Silage Slab Only

5 ½" to 6" reinforced with footings - **\$4.22 to \$4.96** with footings

6" rebar reinforced with footings - **\$5.09 to \$5.81**

(Photograph shown on AH 534.20, page 25)

DAIRY BARNS

LIQUID MANURE SYSTEMS (MANURE SEPARATOR)

Cost includes tanks, pumps, screens, valves, pipes, sump, and drainage system, but excludes cost of all holding ponds or lagoons. Typically, one unit per 800 to 1,000 cows. **\$55,440 to \$72,600**

(Drawing shown on AH 534.20, page 26)

STEEL BULK FEED TANKS ON CONCRETE PAD WITH HOPPER BOTTOM

<u>Components</u>	<u>Cost</u>
5 Ton	\$2,693
9 Ton	\$3,670
10.5 Ton	\$3,736
13 Ton	\$4,448
15 Ton	\$5,306
20 Ton	\$6,461
25 Ton	\$7,042
31 Ton	\$8,514
34 Ton	\$8,567
40 Ton	\$9,708
45 Ton	\$11,134
60 Ton	\$12,236

(Photographs shown on AH 534.20, page 27)

ADDITIVES AND ACCESSORIES

Feeder lines (Per linear foot)	\$9.50
Partition	\$4.22
Ladder	\$277 to \$349
Augar	\$415 to \$547

DAIRY BARNs

GRADE "B" BARNs

Use upper end of cost range for Sacramento Valley and north.

MILK HOUSE

Foundation	Concrete
Floors	Concrete slab
Walls	6" or 8" concrete block 36" high with 2" x 4"—16" on center framing above
Roof	Average wood frame, corrugated iron, or aluminum cover
Windows	Metal sash or metal louvers, 5 percent of wall area
Interior	Smooth finish plaster
Electrical	Fair fixtures
Plumbing	One wash basin
Square-Foot Cost	\$48.40 to \$67.16 per square foot (including breezeway)

MILKING BARNs

Foundation	Light concrete
Floors	Concrete—cow stands
Walls	Box frame, 4" x 6"—10' on center
Roof	Average wood frame, wood shingles, corrugated iron, or aluminum cover
Windows	Barn sash
Interior	Unfinished
Electrical	None
Plumbing	None
Stanchions	Wood stanchions
Square-Foot Costs	\$20.57 to \$26.02 per square foot

Building costs do not include milking equipment.

(Drawing with labels shown on AH 534.20, page 28)

DAIRY BARNs

STANCHION BARNs

High end of range in cost is for Sacramento and Northern California.

MILK, WASH, AND EQUIPMENT ROOMs

Foundation	Reinforced concrete
Floors	Concrete slab
Walls	6" or 8" concrete block 36" high with 2" x 4"—16" on center framing above
Roof	Average wood frame, corrugated iron, or aluminum cover
Windows	Metal sash or metal louvers, 10 percent of wall area
Interior	Smooth finish plaster—cove base
Electrical	Conduit—average fixtures
Plumbing	One wash basin—usual floor drains
Square-Foot Cost	\$51.61 to \$62.44 per square foot (including breezeway)

MILKING BARNs

Foundation	Reinforced concrete
Floors	Concrete—well-formed gutters and mangers
Walls	6" or 8" concrete block 36" high with 2" x 4"—16" on center framing above
Roof	Average wood frame, corrugated iron, or aluminum cover
Windows	Metal sash or metal louvers
Interior	Smooth plaster 36" high
Electrical	Conduit—average fixtures
Plumbing	Usual floor drains and hose bibs
Stanchions	Metal stanchions
Square-Foot Cost	\$51.61 to \$61.71 per square foot

FEED ROOM

Foundation	Reinforced concrete
Floors	Concrete slab
Walls	2" x 4" or 2" x 6"—16" on center framing
Roof	Average wood frame, corrugated iron, or aluminum cover
Windows	None
Interior	Unfinished
Electrical	Conduit—average fixtures
Plumbing	None
Square-Foot Cost	\$20.15 to \$34.00 per square foot

Building costs do not include milking equipment.

(Drawing with labels and descriptions shown on AH 534.20, page 29)

DAIRY BARNs

WALK-THROUGH TYPE BARNs

High end of the range in cost is for Sacramento and Northern California.

MILK, WASH, AND EQUIPMENT ROOMs

Foundation	Reinforced concrete
Floors	Concrete slab
Walls	6" or 8" concrete block 36" high with 2" x 4"—16" on center framing above or all concrete block
Roof	Average wood frame, corrugated iron, or aluminum cover
Windows	Metal sash or metal louvers, 10 percent of wall area
Interior	Smooth finish plaster—cove base
Electrical	Conduit—average fixtures
Plumbing	One wash basin—usual floor drains
Square-Foot Cost	\$43.44 to \$46.22 per square foot (including breezeway)

MILKING BARNs

Foundation	Reinforced concrete
Floors	Concrete—well-formed gutters and mangers
Walls	6" or 8" concrete block 36" high with 2" x 4"—16" on center framing above, or all concrete block
Roof	Average wood frame, corrugated iron, or aluminum cover
Windows	Metal sash or metal louvers
Interior	Smooth plaster 36" high
Electrical	Conduit—average fixtures
Plumbing	Usual floor drains and hose bibs
Stanchions	Metal stanchions
Square-Foot Cost	\$39.63 to \$43.44 per square foot

Building costs do not include milking equipment.

(Drawing with labels and descriptions shown on AH 534.20, page 30)

DAIRY BARNS

COMMONLY USED MILKING PARLORS

HERRINGBONE (DOUBLE 12)

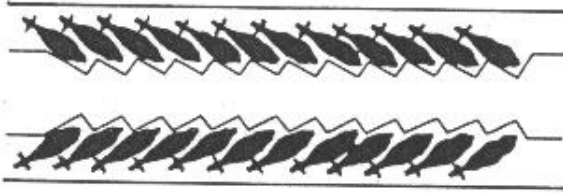

All cows on either side of the pit enter and leave as a group. Newer parlors may have 20 to 30 cows to a side. Some have rapid exit group side release.

POLYGON

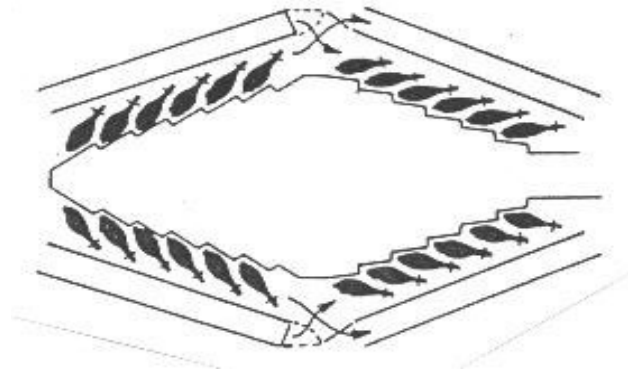

Each of the four sides has separate group entry and exit. Usually, each side is a herringbone configuration, but can have angle modifications.

PARALLEL (DOUBLE 10)

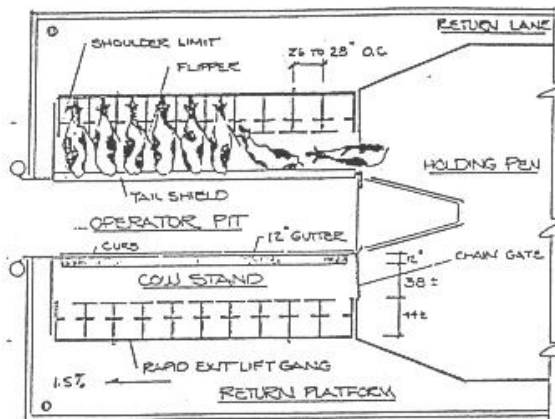

In this design, cows are milked from the rear, rather than the side. Thus, more cows can be milked in a given space than with other designs. Usually, a rapid gang exit is present. Typical size is a double 20' to 30'.

DAIRY BARNS

50-COW ROTARY BARN

OVERVIEW OF ROTARY BARN

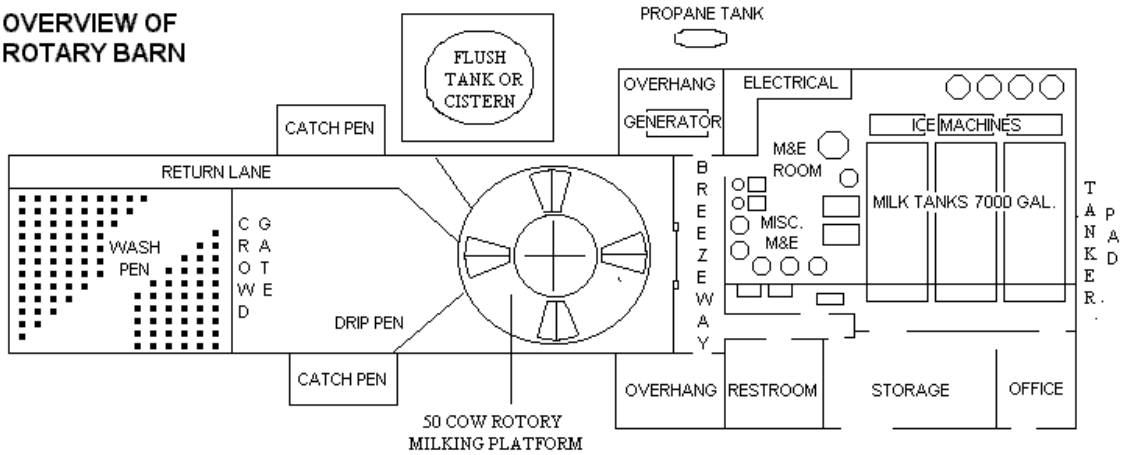

SIDE VIEW

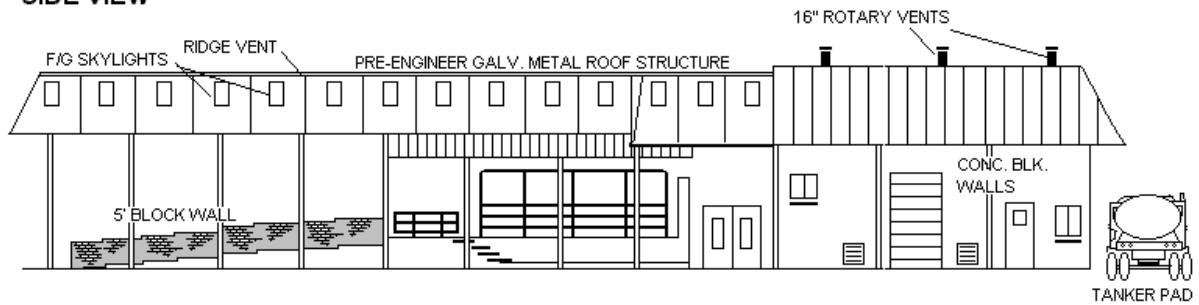

DAIRY BARNS

DOUBLE 30 PARALLEL BARN

OVERVIEW OF PARALLEL BARN

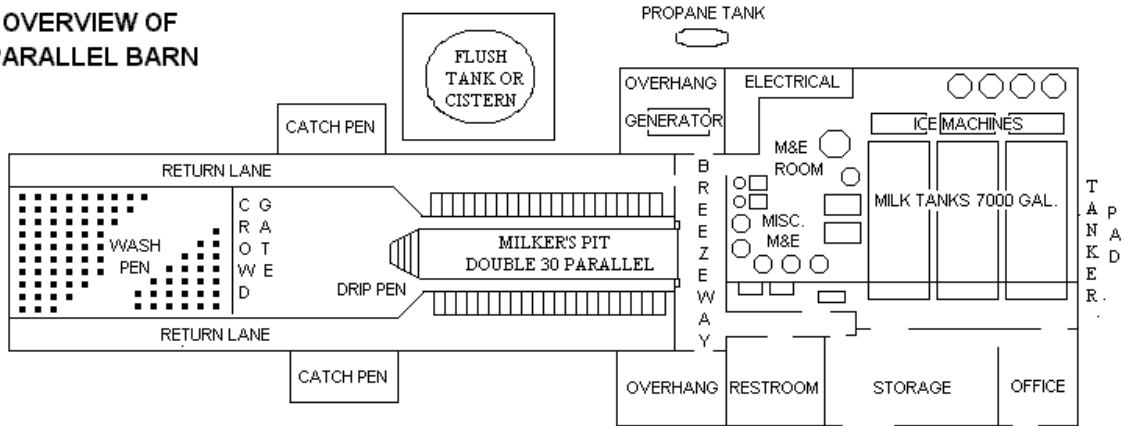

SIDE VIEW

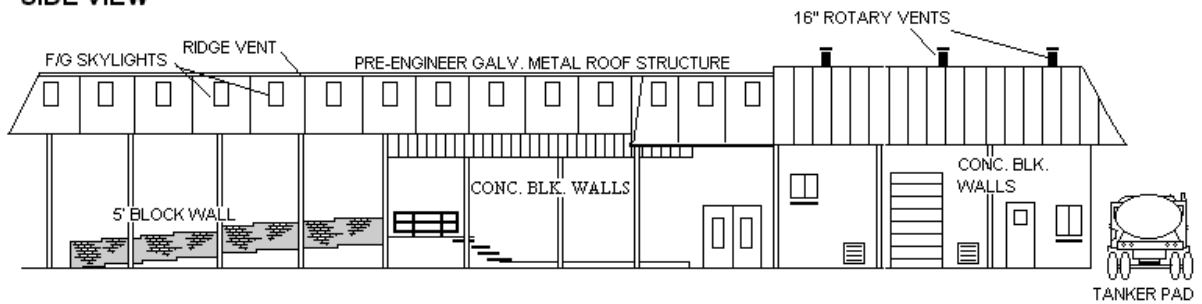

DAIRY BARNS

50-COW ROTARY MILKING PARLOR



DAIRY BARNS

EXTERIOR MODERN HERRINGBONE, PARALLEL, OR ROTARY



Equipment, office, milk room

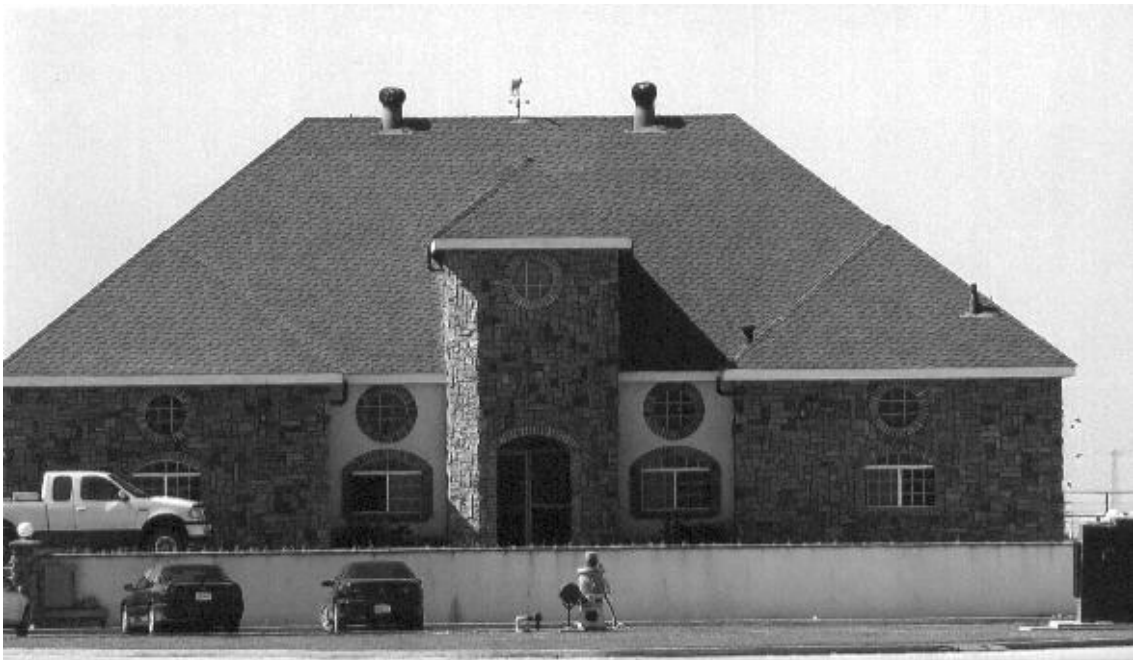

DAIRY BARNS

INTERIOR MODERN HERRINGBONE, PARALLEL, OR ROTARY

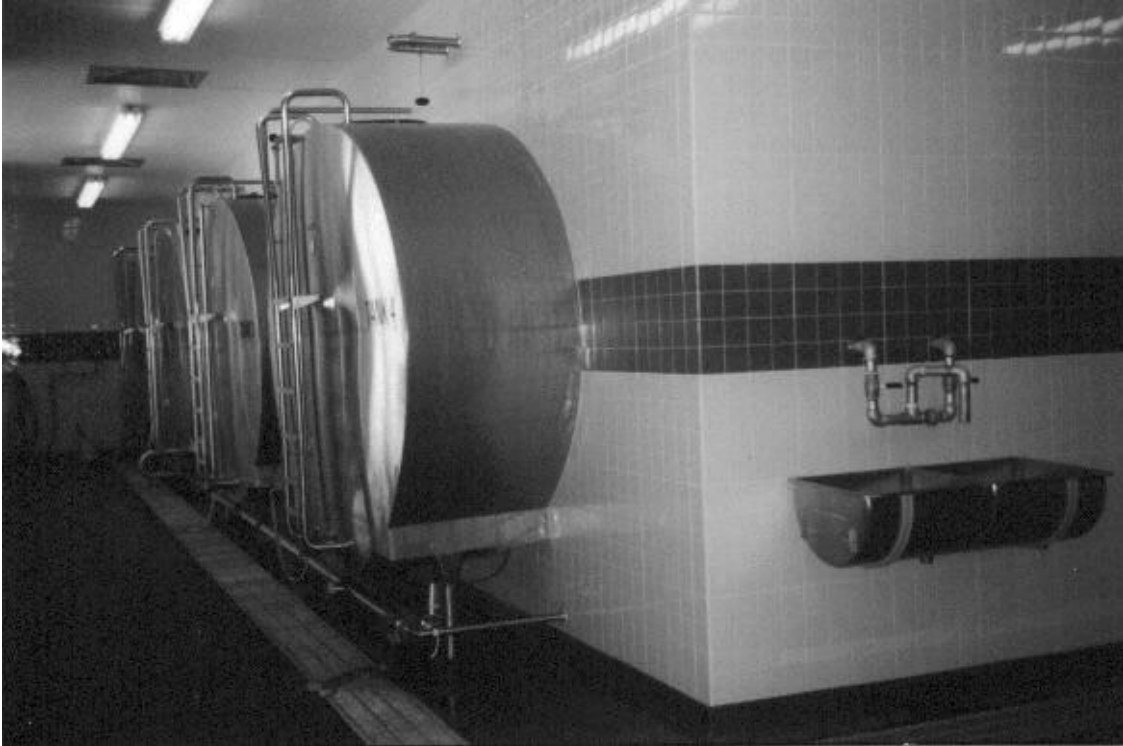

DAIRY BARNS

INTERIOR MODERN HERRINGBONE, PARALLEL, OR ROTARY



DAIRY BARNS

HOLDING, WASH, AND DRIP AREA EQUIPMENT

Wash Pen



DAIRY BARNS

FREESTALL BARN



DAIRY BARN

HOSPITAL BARN



Commodity Barn



DAIRY BARNS

HAY BARN



DAIRY BARNS

MISCELLANEOUS



Feedlane Stanchions



Silage Pits

DAIRY BARNS

LIQUID MANURE SYSTEMS (MANURE SEPARATOR)

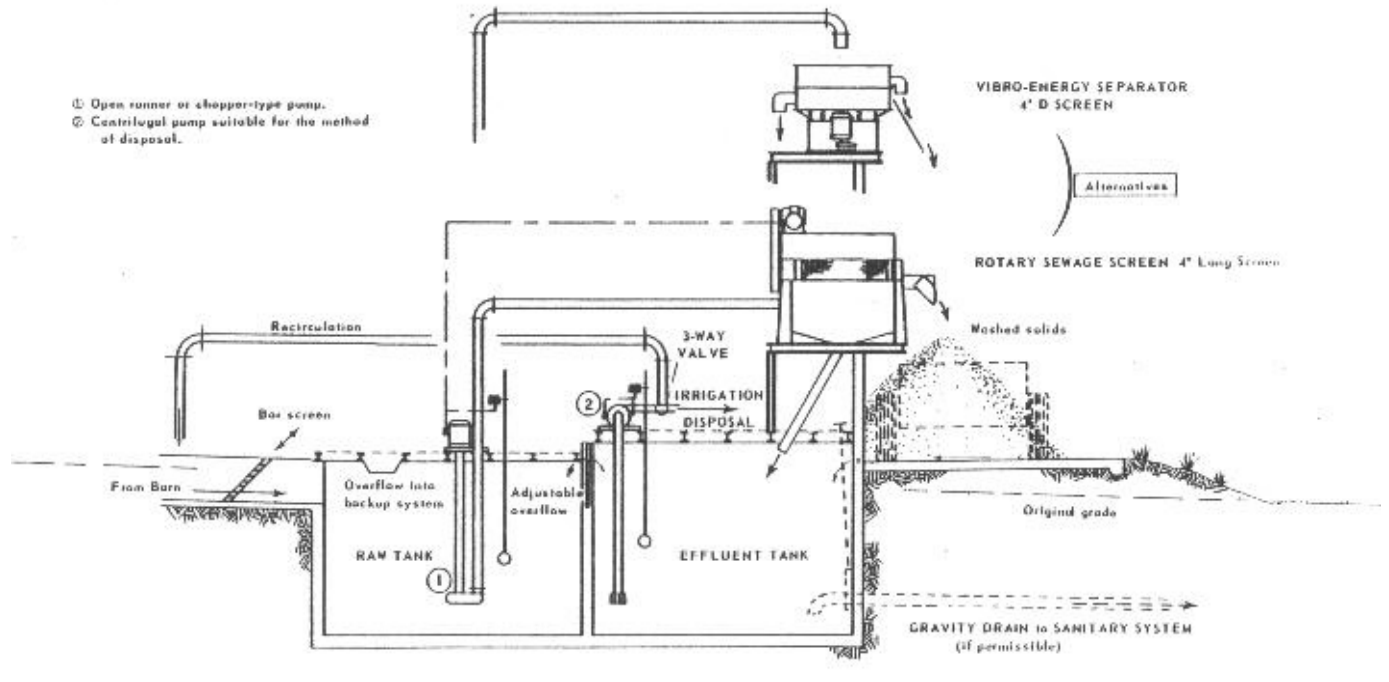

DAIRY BARNS

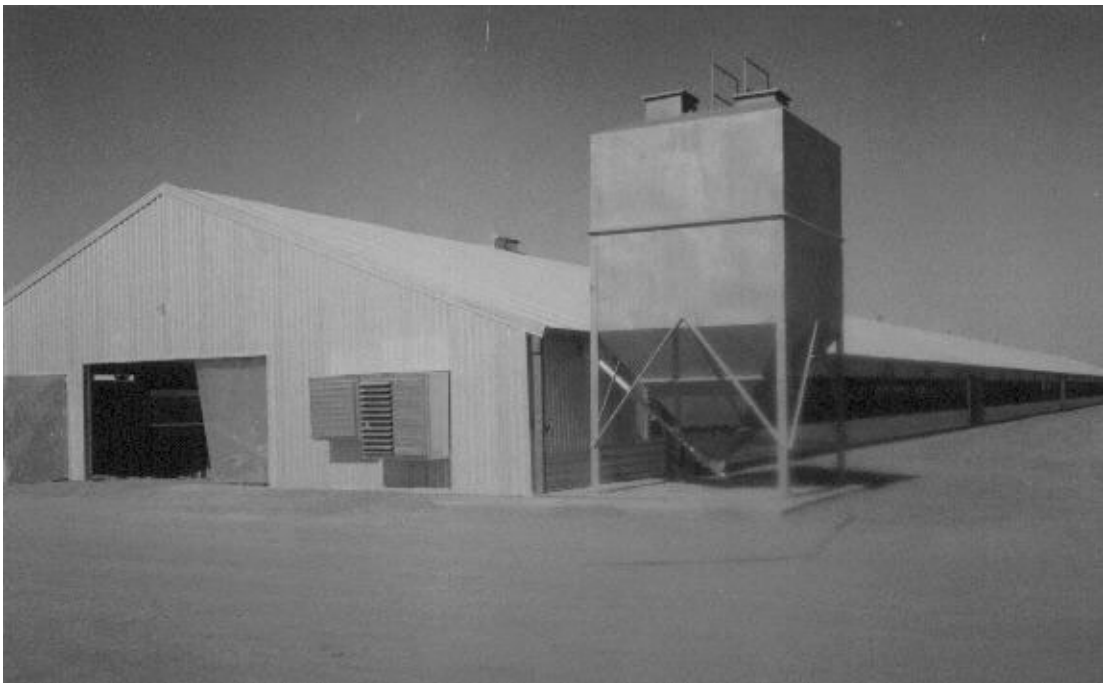

Steel Bulk Feed Tanks on Concrete Pad with Hopper Bottom

DAIRY BARNS

GRADE "B" BARN

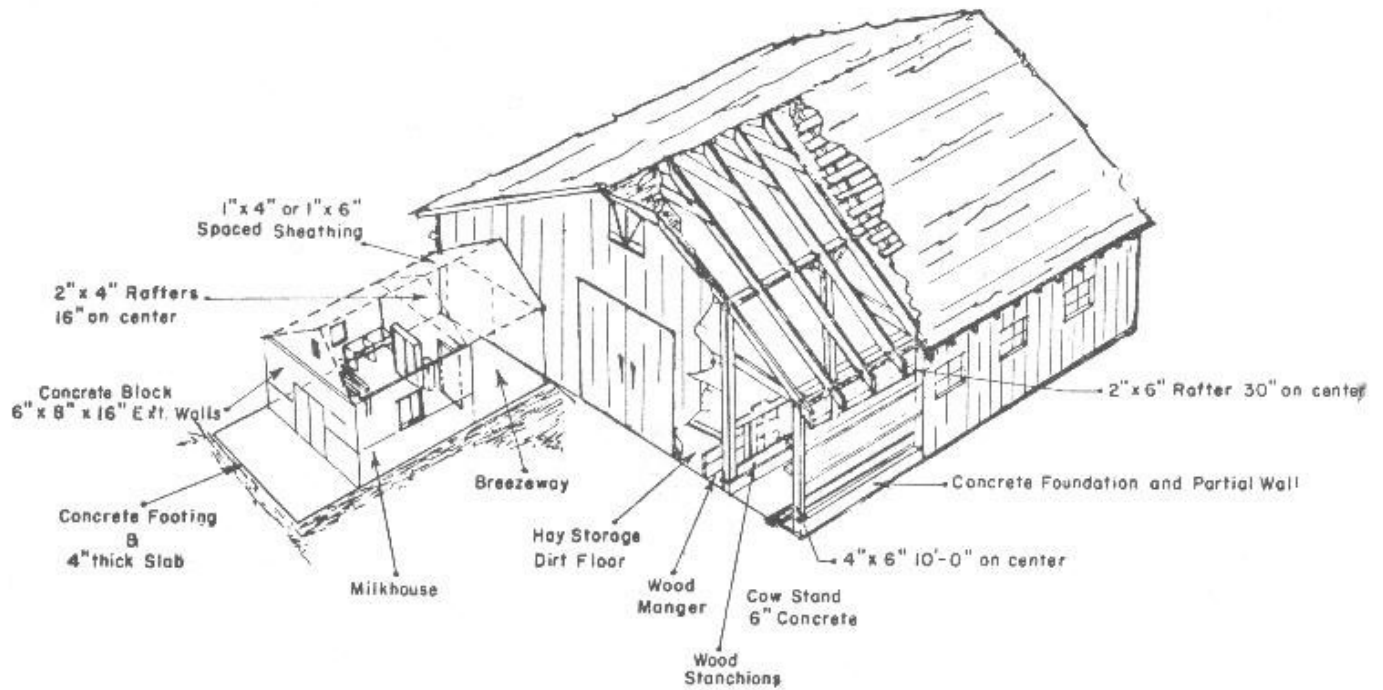

TYPICAL GRADE "B" DAIRY BARN

DAIRY BARN

STANCHION BARN

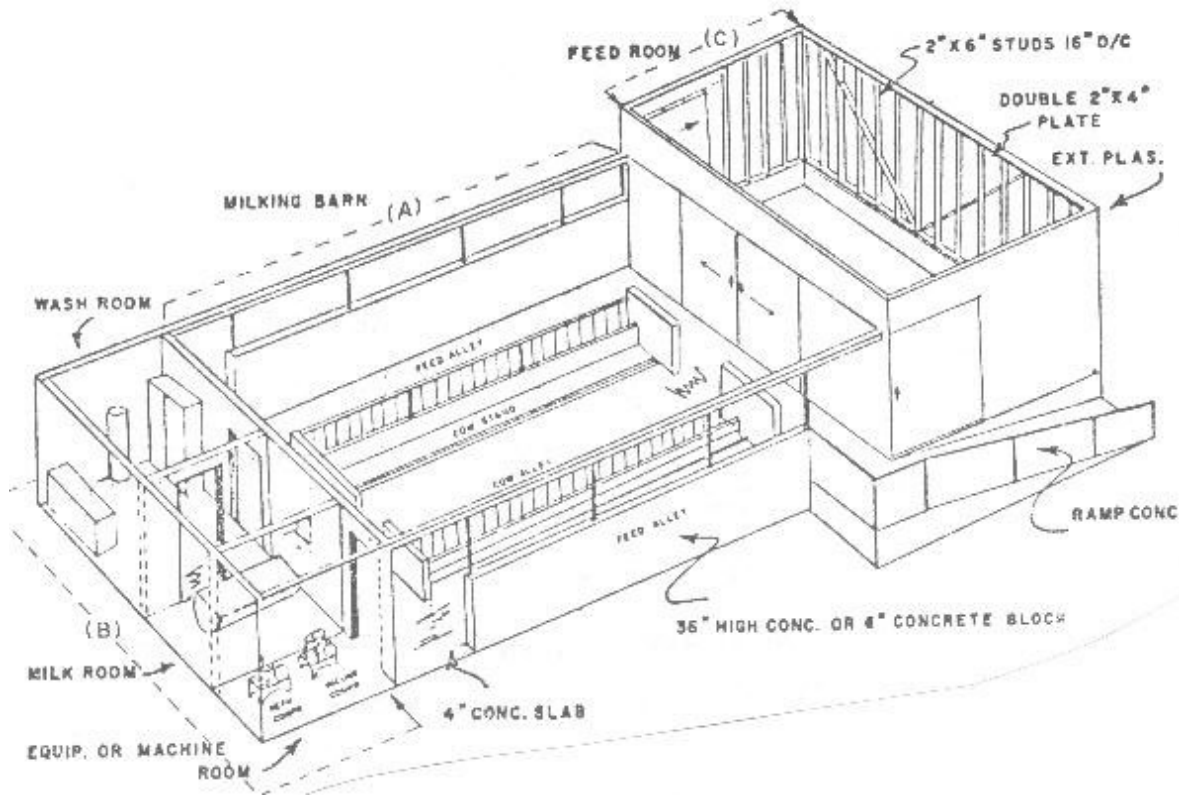

Component Parts of This Dairy

- A. Milking Barn
- B. Milk, Wash, and Equipment Rooms
- C. Feed Room

TYPICAL STANCHION BARN

DAIRY BARNS

WALK-THROUGH TYPE

TYPICAL WALK-THROUGH BARN

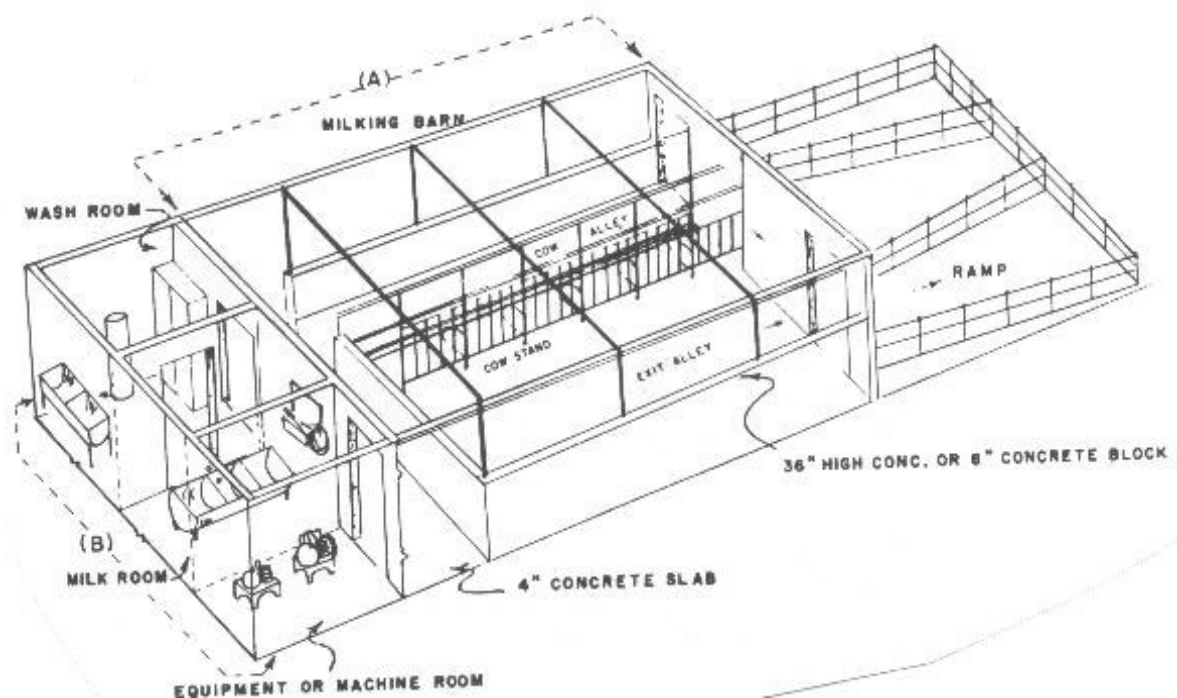

Component Parts of This Dairy

- A. Milking Barn
- B. Milk, Wash, and Equipment Rooms

AH 534.30: POULTRY HOUSES

Poultry houses can be tailored to fulfill a variety of needs depending on the type of farming operation. The three most common types of poultry farming are for egg production, meat production, and "chick" production. Chickens that are farmed mainly for their eggs are called "egg laying hens," chickens farmed for meat are called "broilers," and chickens that lay fertilized eggs for the purpose of producing live "chicks" are called "breeders." The structures that house these three kinds of chickens are known respectively as "layer houses," "broiler houses," and "breeder houses."

This chapter contains specifications and costs for modern poultry structures and equipment used in both types of operations, as well as breeder houses. The building and equipment costs listed below may be used as a baseline for costing other types of poultry houses not specifically mentioned here.

The basic building costs are for the structure only and include only those components specified. The cost of all items of equipment, such as cages, drinking water systems, feeding systems, egg-gathering systems, ventilation systems, and heating and cooling systems, must be added to the basic building cost to arrive at a total cost.

Drawings and photographs showing examples of the buildings and equipment discussed are located at the end of this chapter.

HOUSING - CONVENTIONAL LAYER HOUSES

Components	Average Quality	Good Quality
Foundation	Concrete slab	Concrete slab
Floor	Concrete with some partitions	Concrete with drains or plank floor with drains
Frame	Pole frame	Pole frame
Roof Cover	28-gauge galvanized steel	28-gauge galvanized steel
Exterior	Vinyl curtains or plywood	Plywood with metal siding, air inlets
Lighting	Average system, automatic controls	Good system, excellent wiring, automatic controls
Plumbing	Average system	Good system
Interior	Only roof insulated	Fully insulated, interior sheathing, finished walls
Basic Building Cost Per Square Foot	\$26.94 to \$29.62 per square foot	\$38.99 to \$42.91 per square foot

Typical Size 40' x 400'

(Photograph and drawing shown on AH 534.30, page 4)

POULTRY HOUSES

HOUSING - BROILER HOUSES

Components	Average Quality	Good Quality
Foundation	Concrete slab	Concrete slab
Floor	Dirt	Concrete or dirt
Frame	Pole frame	Pole frame
Roof Cover	28-gauge galvanized steel	28-gauge galvanized steel
Exterior	Vinyl curtains or plywood	Plywood with metal siding
Lighting	Average system, automatic controls	Average system, automatic controls
Plumbing	Average system	Average system
Interior	Only roof insulated, shutters or vents	Fully insulated and ventilated with interior sheathing
Basic Building Cost Per Square Foot	\$15.40 to \$16.99 per square foot	\$18.52 to \$20.33 per square foot

Typical Size 40' x 400'
(Photograph shown on AH 534.30, page 5)

HOUSING - BREEDER HOUSES

Components	Average Quality	Good Quality
Foundation	Concrete slab	Concrete slab
Floor	Dirt	Dirt with some concrete slab
Frame	Pole frame	Pole frame
Roof Cover	28-gauge galvanized steel	28-gauge galvanized steel
Exterior	Vinyl curtains or plywood	Plywood with metal siding
Lighting	Minimal	Average
Plumbing	Minimal	Average
Interior	Only roof insulated, natural ventilation only	Fully insulated and ventilated, interior sheathing
Basic Building Cost Per Square Foot	\$17.06 to \$18.82 per square foot	\$20.11 to \$22.07 per square foot

Typical Size 40' x 400'
(Photograph shown on AH 534.30, page 6)

POULTRY HOUSES

EQUIPMENT - CONVENTIONAL LAYER CAGE HOUSES

Components	A-Frame Cages	Battery Cages
Cages	3 to 5 tier	4 to 8 tier
Watering System	Automatic nipple system	Automatic nipple system
Feeding System	Automatic auger system	Automatic auger system
Egg-Gathering System	Automatic belt system	Automatic belt system
Manure Management System	Manual tray	Automatic belt
Cooling	Evaporative cooling pad and house fan system	Evaporative cooling pad and house fan system
Heating	None	None
Total Cost Per Bird Equipment	\$10.29 to \$11.33 per bird	\$17.27 to \$18.98 per bird

Assuming 0.48 square feet per bird.

(Photographs and drawings shown on AH 534.30, pages 7 and 8)

EQUIPMENT - MODERN BROILER HOUSES

Components	
Watering System	Automatic nipple system
Feeding System	Automatic auger system
Cooling	Pad and fan system
Heating	Gas brooders
Total Cost Per Bird Equipment	\$3.96 to \$4.35 per bird

Assuming 0.80 square feet per bird.

(Photographs and drawing shown on AH 534.30, pages 9 - 11)

EQUIPMENT - MODERN BREEDER HOUSES

Components	
Watering System	Automatic nipple system
Feeding Systems	Female and male bin and fill system
Cooling	Pad and fan system
Egg-Gathering System	Nest and egg collection system
Total Cost Per Bird Equipment	\$10.45 to \$11.55 per bird per bird

Assuming 1.90 square feet per bird.

(Photographs and drawing shown on AH 534.30, pages 9 - 11)

POULTRY HOUSES

CONVENTIONAL LAYER HOUSE

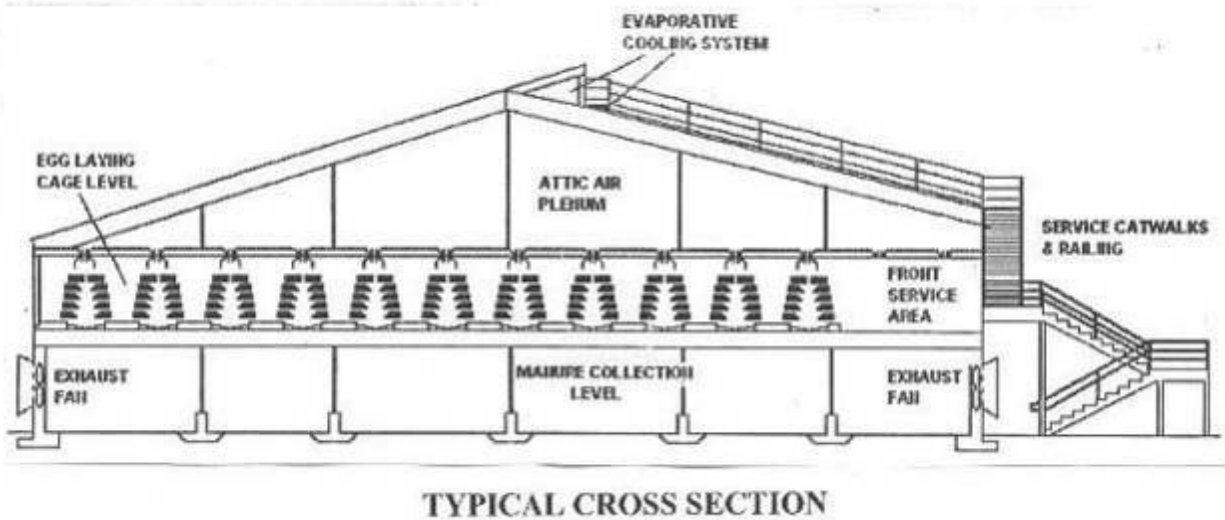

POULTRY HOUSES

BROILER HOUSE



POULTRY HOUSES

BREEDER HOUSE



POULTRY HOUSES

A-FRAME CAGE EQUIPMENT

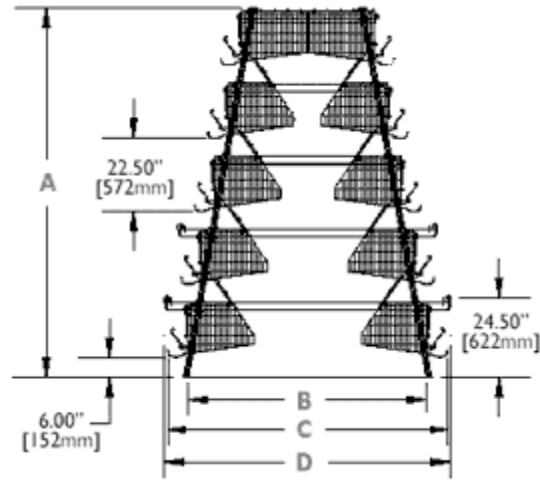

CONVENTIONAL A-FRAME CAGE LAYER HOUSE

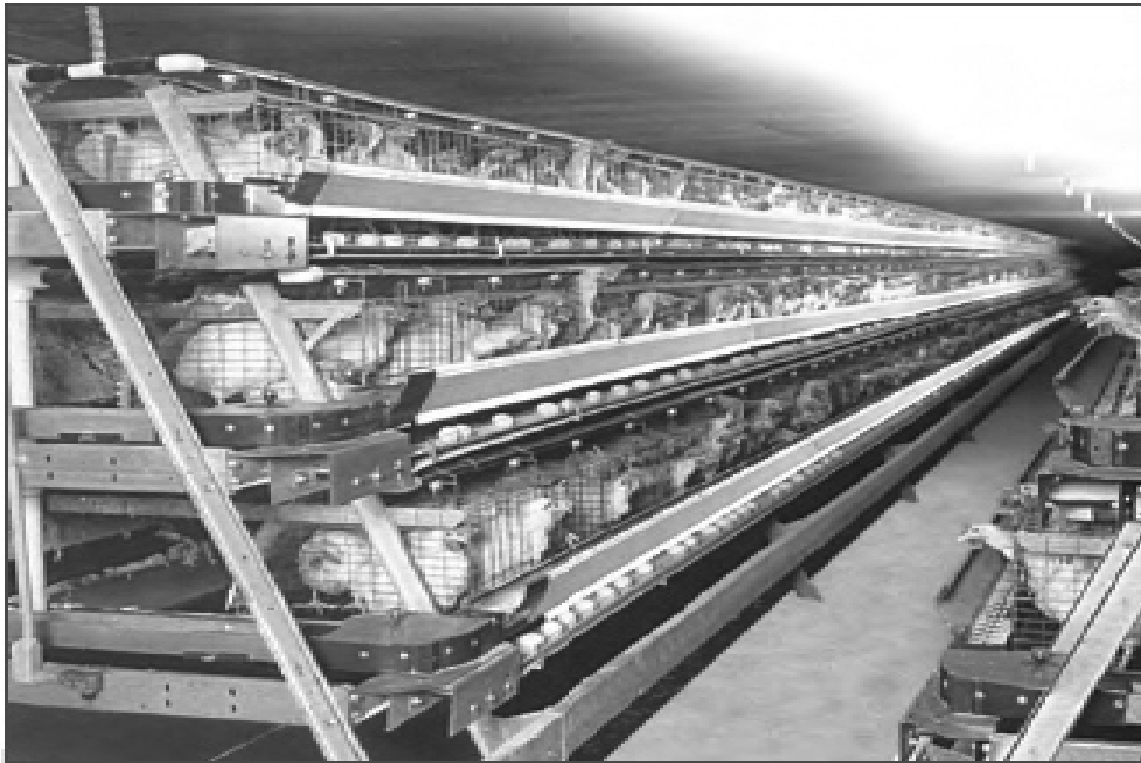

POULTRY HOUSES

BATTERY CAGE EQUIPMENT

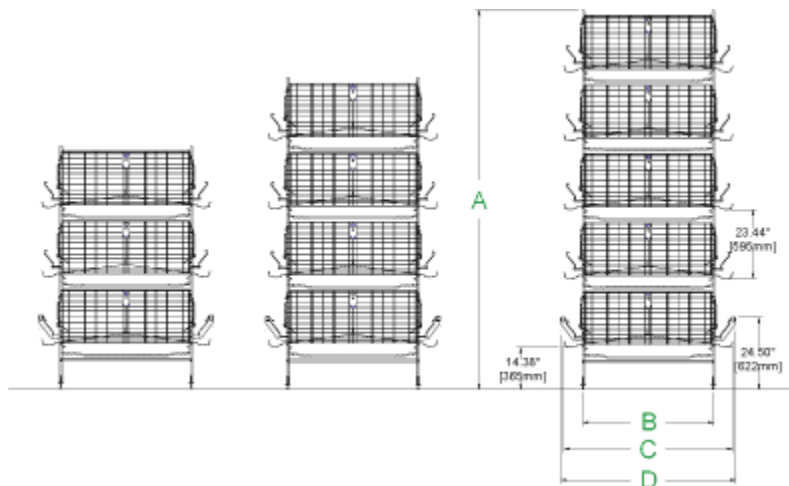

CONVENTIONAL BATTERY CAGE LAYER HOUSE



POULTRY HOUSES

EVAPORATIVE COOLING PADS



HOUSE FAN

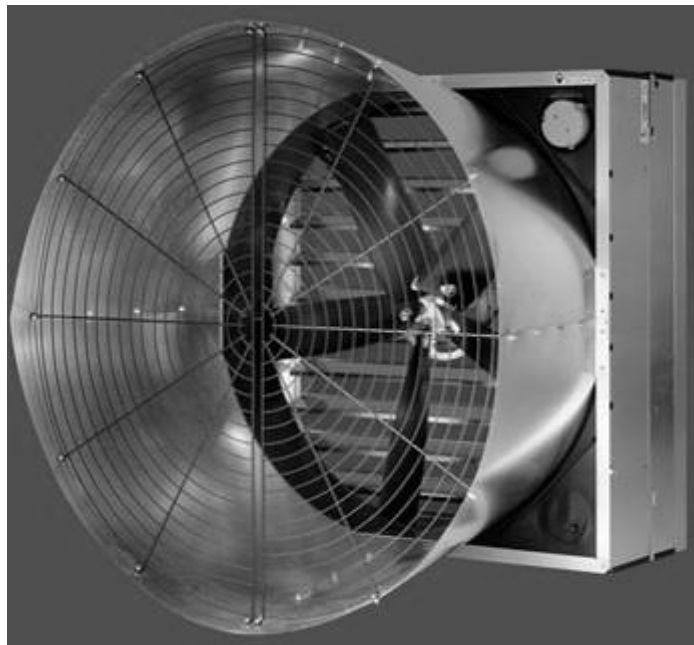

POULTRY HOUSES

AUGER FEEDING SYSTEM DIAGRAM

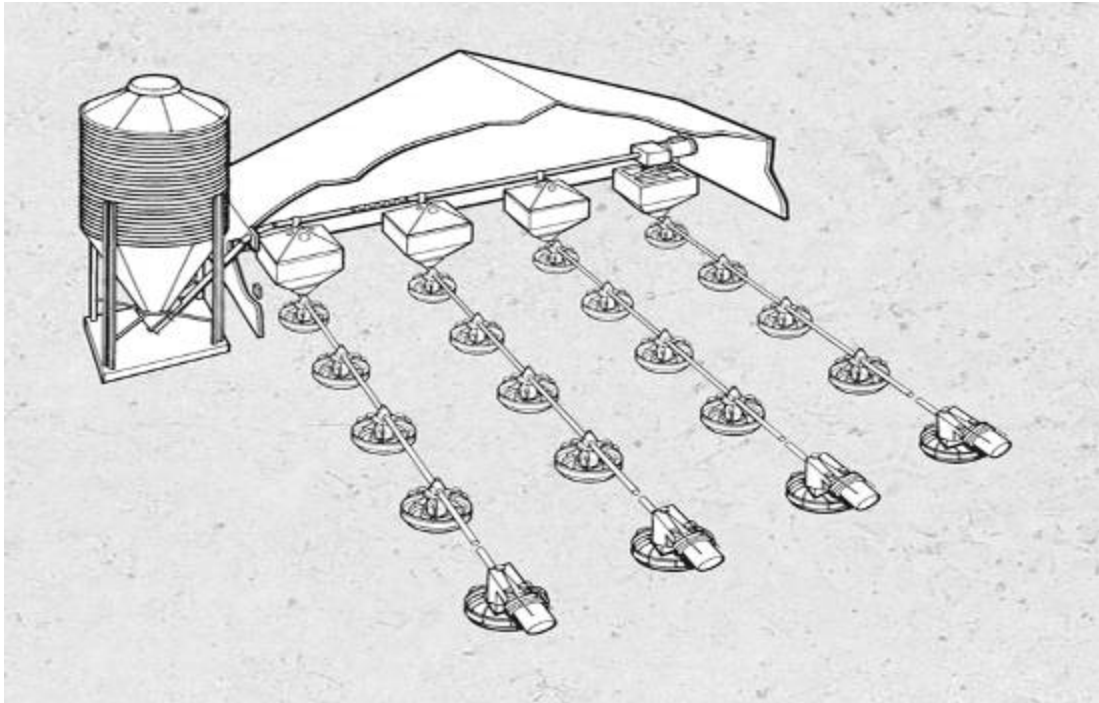

EGG COLLECTION SYSTEM



POULTRY HOUSES

GAS BROODER



AH 534.61: IRRIGATION SYSTEMS

This chapter contains specifications and costs for various irrigations systems, including:

- Concrete pipe
- PVC pipe
- Aluminum pipe
- Irrigation valves
- Permanent irrigation system
- Concrete ditch

Photographs showing examples of systems discussed are located at the end of this chapter.

The following costs for irrigation system components have been derived from information gathered, for the most part, in the San Joaquin and Sacramento Valleys. Costs have been collected only for the more widely used components. Many areas will have types of equipment not usually found in other locations. Costs for those items or systems should be checked locally.

CONCRETE PIPE - INSTALLED

Size in Inches	Cost Installed Per Linear Foot		Vertical Stand Pipe Including Base Installed Cost Per Foot of Height	
	Fresno Area	Sacramento North	Fresno Area	Sacramento North
8	\$9.35	\$9.79	\$21.18	\$22.22
10	\$9.68	\$10.12	\$25.85	\$27.17
12	\$10.78	\$11.33	\$27.06	\$28.38
14	\$11.88	\$12.43	\$29.43	\$30.91
16	\$13.20	\$13.86	\$44.44	\$46.64
18	\$14.08	\$14.74	\$50.16	\$52.69
20	\$17.11	\$17.93	\$51.32	\$53.90
24	\$26.40	\$27.72	\$91.08	\$95.65
30	\$66.00	\$69.30	\$159.12	\$167.09
36	\$85.69		\$176.66	\$185.46
42			\$250.25	\$262.79
48			\$353.32	\$370.98

The prices shown above are for installations over 700 feet in length. Adjust these prices for installations less than 700 feet by using an appropriate dollar figure from the next page. The use of PVC pipe has become more prevalent than concrete pipe in most areas. Concrete pipe is still used primarily in the southern San Joaquin Valley.

IRRIGATION SYSTEMS

CONCRETE PIPE - INSTALLED

Adjust the prices from the previous page for installations less than 700 feet by the following amount.

<u>Length of Pipe</u>	<u>Add to All Sizes</u>
Up to 100'	\$8.25 per foot
100' to 200'	\$6.49 per foot
200' to 300'	\$5.39 per foot
300' to 400'	\$3.52 per foot
400' to 500'	\$2.97 per foot
500' to 600'	\$2.37 per foot
600' to 700'	\$1.76 per foot

PRESSURE BOXES (Reinforced concrete with capped top)

Size	Price Per Linear Foot of Height
24"	\$407
30"	\$572
36"	\$710

STAND PIPE INCLUDING THE BASE-COST PER LINEAR FOOT

Size	6'	9'	12'	15'
24"	\$583	\$875	\$1,166	\$1,463
30"	\$1,023	\$1,529	\$2,041	\$2,552
36"	\$1,133	\$1,700	\$2,266	\$2,833
42"	\$2,310	\$2,404	\$3,207	\$4,010
48"	\$2,316	\$3,399	\$4,532	\$5,660

VENT PIPE—PLASTIC—COST PER FOOT

Size	9' Height Limit
2"	\$13 per foot
3"	\$14 per foot
4"	\$19 per foot

IRRIGATION SYSTEMS

CONCRETE PIPE - INSTALLED

VENT PIPE—STEEL—COST PER FOOT

Size	9' Height Limit
2"	\$15 per foot
4"	\$22 per foot
6"	\$26 per foot
8"	\$34 per foot
10"	\$43 per foot
12"	\$47 per foot

ADD HOOK-UP (When new concrete pipe is connected to old concrete pipe, add the following:)

Size	Add
8", 10", and 12"	\$288
14", 16", and 18"	\$347
20" and 24"	\$404

PVC PIPE

Cost includes components and installation, but not hook-up to pump. As pressure requirements rise, the pipe becomes more costly.

PVC PIPE— COST INSTALLED (PER LINEAR FOOT)

Size	Class 63 Low Head (Flood)	100 P S I (Sprinkler)
6"	\$5.23	\$6.27
8"	\$6.05	\$7.70
10"	\$9.08	\$10.67
12"	\$12.43	\$13.64
15"	\$13.31	\$18.87
18"	\$24.20	\$26.29

PVC hook-up to pump—includes relief valves, check valves, dresser couplings, elbows, and labor.

IRRIGATION SYSTEMS

PVC PIPE

ADD HOOK-UP

Size	Cost
6"	\$933
8"	\$1,397
10"	\$1,865
12"	\$2,448

VALVE, SADDLE, AND RISER (FOR SURFACE LATERALS)

Size	Sprinkler	Flood
4"	\$90	\$125
8"	-	\$217
10"	-	\$268
12"	-	\$330
14"	-	\$440

ALUMINUM PIPE

Aluminum pipe costs include sales tax, but exclude installation costs due to their portable nature.

Main Lines Per Linear Foot	Diameter			
	6"	8"	10"	12"
Ring Lock Type				
40' joints <u>without</u> valve	\$4.79	\$6.60	\$8.36	\$9.02
40' joints <u>with</u> valve	\$5.28	\$7.92	\$9.90	\$10.73
Latch Type	3"	4"	6"	
30' joints <u>without</u> valve	\$1.54	\$2.59	\$3.74	

SPRINKLER LINES

18" Risers—30' lengths 3"—**\$2.04** per linear foot 4"—**\$2.75** per linear foot

IRRIGATION SYSTEMS

GALVANIZED FITTINGS

Valve Openers		End Plugs		90° Elbows	
Size	Cost	Size	Cost	Size	Cost
4"	\$176	6"	\$50	6"	\$127
6"	\$209	8"	\$66	8"	\$171
8"	\$270	10"	\$99	10"	\$220

IRRIGATION VALVES

Flood valves are set near the top or flush on top of a concrete pipe riser. Several types are in general use, such as, Yakima and Alfalfa. They are made with either a solid arch or a removable arch. The removable arch type is more expensive, but it allows for replacement of the arch without complete valve removal when breakage occurs. The solid arch is usually found to be a Yakima and the removable arch is an Alfalfa.

FLOOD VALVES—COST PER VALVE

Size in Inches	Solid Arch Yakima	Size in Inches	Alfalfa
3 x 8	\$97		
4 x 8	\$100	8 x 8	\$220
5 x 8	\$109	10 x 10	\$253
6 x 10	\$138	12 x 12	\$319
8 x 12	\$172	14 x 14	\$352
10 x 14	\$229		
12 x 16	\$281		
14 x 18	\$347		
16 x 20	\$539		
18 x 20	\$572		
20 x 20	\$693		

(Photographs shown on AH 534.61, page 12)

IRRIGATION SYSTEMS

IRRIGATION VALVES

OVERFLOW VALVES

Size in Inches	Cost Installed
3 x 8	\$94
3 1/2 x 8	\$94
4 x 8	\$96
5 x 8	\$107
5 x 10	\$107
6 x 10	\$144
6 1/2 x 10	\$144
8 x 12	\$171
10 x 14	\$242
12 x 16	\$311
14 x 18	\$385
16 x 20	\$554
18 x 20	\$688
20 x 24	\$860

The orchard valve is a solid arch set down in a riser. Although it is generally used in orchards, it may also be found in row crops and pastures.

PVC ORCHARD VALVE

Valve Size	Riser Size	Cost
3 1/2"	8"	\$90
4"	8"	\$113
5"	8"	\$113
6"	10"	\$145
6 1/2"	10"	\$145
8"	12"	\$173
10"	14"	\$242
12"	16"	\$306
14"	18"	\$360
16"	20"	\$537
18"	21"	\$658
20"	24"	\$803

IRRIGATION SYSTEMS

IRRIGATION VALVES

The vineyard valve is a modification of the orchard valve. The riser is pierced with two or more small galvanized tubes, which have small sliding galvanized gates. This arrangement allows a choice of direction and volume of water flow. This valve is found mainly in the Central San Joaquin Valley.

VINEYARD VALVE

Valve Size	Riser Size	Number of Gates	Gate Size	Cost Installed
3 1/2"	8"	2	2"	\$91
3 1/2"	8"	2	2 1/2"	\$95
3 1/2"	8"	2	3"	\$100
3 1/2"	8"	3	2"	\$102
3 1/2"	10"	2	2"	\$98
3 1/2"	10"	2	2 1/2"	\$99
3 1/2"	10"	2	3"	\$99
4"	8"	2	2"	\$100
4"	8"	2	2 1/2"	\$101
4"	8"	2	3"	\$106
4"	10"	2	2"	\$102
4"	10"	2	2 1/2"	\$105
4"	10"	2	3"	\$111
4"	10"	3	2"	\$109
4"	10"	4	2"	\$113
5"	10"	4	2"	\$138
5"	12"	2	3"	\$134
6"	10"	2	3"	\$120
6"	10"	4	3"	\$138
6"	12"	2	3"	\$143
6"	12"	2	4"	\$151

IRRIGATION SYSTEMS

IRRIGATION VALVES

Gate valves have different designs depending on the use. The canal gate is for general low-pressure uses as canal discharges, pressure pipelines, etc. The screw-pressure gate is a high-pressure gate valve used for reservoirs, etc. The hub-end gate is designed for use in pipelines.

GATE VALVES—COST PER VALVE

Size in Inches	Screw Pressure	Canal Gate	Hub-End Gate	Clamp Gate	Baxter Gate	Galvanized Gate
6						\$94
8	781		\$1,243	\$517		\$127
10	902	\$880	\$1,463	\$803		\$138
12	1,023	\$891	\$1,727	\$858	\$1,375	\$160
14	1,320	\$1,045	\$2,079	\$1,144		\$193
16	2,112	\$1,155	\$2,695	\$1,375	\$1,716	\$226
18	2,893	\$1,276	\$3,410			\$248
20	3,267	\$1,672	\$4,125			\$275
24	3,740	\$1,870	\$9,020			\$275
36		\$3,432				
48		\$7,656				
60		\$13,640				

(Photographs shown on AH 534.61, page 12)

Capped riser irrigation systems are generally found in old orange groves. The galvanized gates are diamond shaped.

CAPPED RISERS

Size	Number of Gates	Size of Gates	Installed Cost
8"	2	2"	\$48
8"	3	1"	\$50
8"	4	1"	\$56

AIR RELIEF VALVES—COST PER VALVE

Size	Installed on PVC	Installed on Concrete Pipe
2"	\$143	\$165
3"	\$237	\$264
4"	\$303	\$385

IRRIGATION SYSTEMS

PERMANENT IRRIGATION SYSTEM

The larger set-ups are at lower end of range.

SPRINKLERS— "SOLID SET"—UNDER TREES

Type	Cost Per Acre
Manual system	\$990 to \$1,430
Automatic system	\$1,265 to \$1,760
Frost protection system	\$1,386 to \$2,002
Automatic system with frost protection	\$1,716 to \$2,431

PVC underground lines, 12" risers, impact sprinkler heads, screen filter

SPRINKLERS—"SOLID SET"—OVER VINES

Type	Cost Per Acre
Manual system	\$1,155 to \$1,485
Automatic system	\$1,485 to \$1,815
Frost protection system	\$2,057 to \$2,860
Automatic system with frost protection	\$2,409 to \$3,553

PVC underground lines, 12" risers, impact sprinkler heads, screen filter

DRIP SYSTEM—ORCHARD

Type	Cost Per Acre
New planting (1 to 4 emitters per tree)	\$1,404 to \$1,989
Mature orchard (4 emitters per tree)	\$1,521 to \$2,223

DRIP SYSTEM—VINEYARD

Type	Cost Per Acre	Additives
Ratio of cost—70 percent above ground, 30 percent below ground, add	\$1,755 to \$2,808	
Sand filters (for dirty water-aqueduct and river water), add		\$246 to \$410
Fertilizer application equipment, add		\$936 to \$1,112
When proportion pumps are used, add		\$1,697 to \$2,750

Automatic systems can add \$300 to \$400 to the total cost while frost protection can add 40 percent to 60 percent to the total cost.

DRIP TAPE

Orchard/Vineyard/Row Crop	Cost Per Acre	Additives
For all installations	\$761 to \$995	
Use upper range for vineyard/orchard		
Elaborate stainless steel sand media filters (for dirty water-aqueduct and river water), add		\$4,680 to \$8,190
Basic Sand filters (for dirty water-aqueduct and river water), add		\$246 to \$410
Fertilizer application equipment, add		\$936 to \$1,112
When proportion pumps are used, add		\$1,697 to \$2,750

Market research indicates that most new irrigation systems installed for orchard and vineyard crops use drip systems or drip tape systems. Row crops are increasingly being irrigated by drip tape.

IRRIGATION SYSTEMS

PERMANENT IRRIGATION SYSTEMS

HOSE PULL SYSTEM

Type	Cost Per Acre
Plus pump and filter	\$644 to \$819

LINEAR OVERHEAD SPRINKLER SYSTEM

Size	Cost Each
320 Acres	\$167,200 to \$198,000

The linear overhead sprinkler system is used on a level parcel usually a one-half section of land. A canal runs through the parcel as a water supply.

(Photographs shown on AH 534.61, page 13 and 14)

ELECTRIC CENTER PIVOT SPRINKLER—Including concrete base

Size	Cost Each
160 acres (130 acres net) – New	\$57,200 to \$66,000
160 acres (130 acres net) – Used 12-15 years	\$24,200 to \$33,000

(Photographs shown on AH 534.61, page 15)

Concrete Structures	\$400 per cubic yard
Control Gates	\$200
Hook-up and Connections	Between no charge and \$240

CRIBBINGS

Size in Inches	Cost Per Linear Foot
24	\$168
30	\$224
36	\$246

The concrete riser above the valve is cut in half to direct the flow of water.

IRRIGATION SYSTEMS

CONCRETE DITCHES

Costs are for one-half to one mile runs. Shorter runs are a little higher.

<u>Bottom</u>	<u>Depth</u>	<u>Cost Per Foot</u>
1'	16"	\$13.20
1'	18"	\$13.53
1'	20"	\$14.19
1'	22"	\$15.07
1'	24"	\$15.51
1'	26"	\$16.39
1'	28"	\$16.83
1'	30"	\$17.82
2'	24"	\$22.66
2'	27"	\$23.43
2'	30"	\$26.40
2'	34"	\$28.38
2'	36"	\$29.37
2'	38"	\$30.36
2'	40"	\$31.35
2'	42"	\$32.34
2'	44"	\$34.65
2'	46"	\$35.86
2'	48"	\$38.94

The above costs do not include end gates and turn out gates. They range from **\$138 to \$171** each (three joints 12" x 14" in diameter). Check gates cost **\$495**.

The above prices do include the land shaping.

IRRIGATION SYSTEMS



ALFALFA VALVE

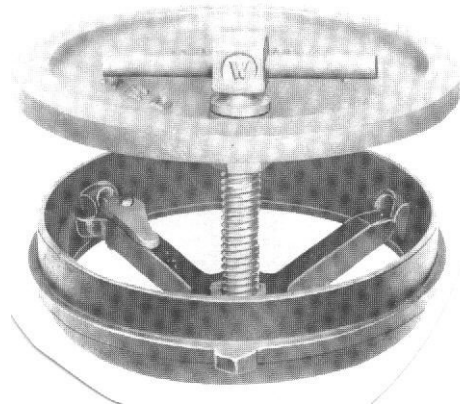

YAKIMA VALVE

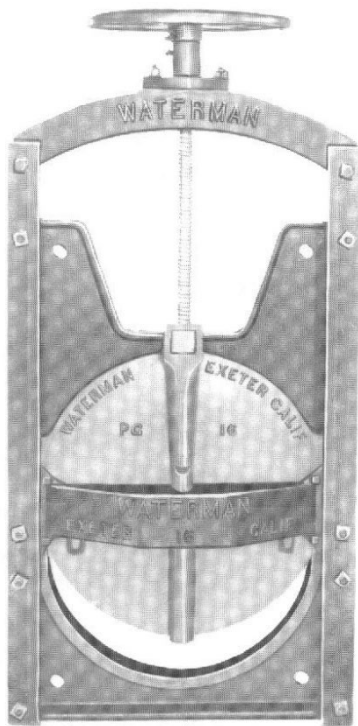

PRESSURE SLIDE GATE

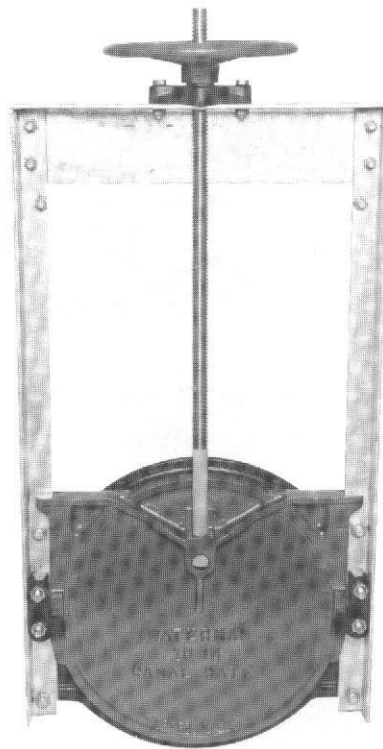

CANAL GATE



HUB END GATE

IRRIGATION SYSTEMS



LINEAR OVERHEAD SPRINKLER



LINEAR OVERHEAD SPRINKLER

IRRIGATION SYSTEM



LINEAR OVERHEAD SPRINKLER



LINEAR OVERHEAD SPRINKLER

IRRIGATION SYSTEM



CENTER PIVOT SPRINKLER (PIVOT SIDE)



CENTER PIVOT SPRINKLER

AH 534.62: PUMPS

This chapter contains specifications and costs for various pumps used with irrigation systems, including:

- Turbine pumps
- Diesel powered pumps
- Submersible pumps
- Wells
- Windmills

Photographs showing examples of the pumps discussed are shown at the end of this chapter.

SAN JOAQUIN VALLEY BASE TURBINE PUMPS 3-PHASE FREE FLOW DISCHARGE

1,800 RPM, 5 to 350 HP installed, including pump complete in place with normal stages, power pole, pads, and control panel. Well and casing excluded.

COST INSTALLED

HP	Depth of Setting											
	40'	60'	80'	100'	120'	140'	160'	180'	200'	220'	260'	300'
5	\$10,363	\$10,465	\$11,782	\$12,750	\$14,426							
8	\$10,568	\$10,674	\$12,272	\$13,063	\$15,654	\$16,826	\$18,640	\$19,962	\$21,558			
10	\$11,032	\$12,272	\$13,717	\$14,904	\$16,336	\$17,045	\$18,980	\$20,454	\$21,871	\$23,316	\$26,222	
15	\$12,872	\$14,113	\$15,626	\$16,882	\$18,176	\$18,176	\$20,425	\$22,062	\$23,958	\$25,471	\$28,990	\$31,771
20	\$16,446	\$17,503	\$17,846	\$19,658	\$20,564	\$21,566	\$22,555	\$23,612	\$25,465	\$27,497	\$30,792	\$33,689
25	\$17,503	\$18,025	\$19,631	\$21,758	\$22,555	\$23,324	\$25,204	\$27,058	\$28,925	\$30,490	\$31,286	\$34,470
30	\$19,644	\$20,688	\$21,457	\$22,830	\$23,887	\$25,204	\$26,550	\$27,854	\$29,185	\$30,792	\$33,181	\$35,816
40	\$21,737	\$22,267	\$22,830	\$24,133	\$27,044	\$28,651	\$30,257	\$31,849	\$33,440	\$34,470	\$38,411	\$41,129
50	\$22,555	\$25,204	\$27,854	\$29,172	\$30,490	\$31,862	\$33,181	\$34,470	\$38,452	\$39,798	\$45,096	\$47,746
60		\$29,172	\$30,490	\$33,181	\$34,470	\$35,830	\$37,162	\$38,452	\$41,116	\$45,096	\$50,410	\$53,059
75		\$33,194	\$34,470	\$38,452	\$39,977	\$41,143	\$42,461	\$45,096	\$47,746	\$50,410	\$58,399	\$61,021
100		\$34,486	\$38,452	\$41,143	\$45,096	\$47,760	\$50,423	\$53,046	\$54,391	\$57,040	\$61,008	\$63,685
125		\$41,143	\$45,096	\$47,746	\$50,410	\$53,059	\$57,040	\$59,689	\$64,082	\$68,970	\$74,996	\$76,849
150			\$47,746	\$49,860	\$53,087	\$57,040	\$61,021	\$63,671	\$66,334	\$72,952	\$79,609	\$82,231
200			\$50,410	\$51,535	\$58,399	\$66,334	\$68,983	\$74,297	\$76,945	\$82,259	\$90,221	\$92,773
250						\$86,792	\$89,672	\$92,639	\$98,360	\$104,136	\$107,033	\$115,718
300						\$101,269	\$104,150	\$109,969	\$115,718	\$118,182	\$124,405	\$127,285
350						\$122,059	\$124,291	\$127,285	\$133,076	\$135,944	\$138,866	\$144,516

Note: The appraiser must know the horsepower and depth of setting in order to estimate the replacement cost new from the chart.

Turbine pumps are more commonly used than submersibles, primarily due to accessibility of the pump for maintenance purposes. Diesel powered pumps are primarily used when there is limited to no power and intended for permanent applications with the use of long-range fuel tanks. Submersible pumps tend to exceed the cost of turbines at high settings and tend to be less costly at lower settings.

Add 10 percent to the above replacement cost new factors for irrigated sprinkler systems.

(Photograph shown on AH 534.62, page 10)

PUMPS

DIESEL POWERED DEEP WELL IRRIGATION PUMPS

The complete costs installed are divided into three parts: engines, gear heads, and below ground assembly. Costs are based on data from Fresno to the Southern San Joaquin Valley.

DIESEL ENGINES NEW (Includes Tax and Delivery)

HP	Cost
75 – 100	\$15,608 - \$20,328
100 – 150	\$20,328 - \$27,298
150 – 200	\$27,298 - \$32,815
200 – 250	\$32,815 - \$39,059
250 – 300	\$39,059 - \$46,828
300 – 400	\$46,828 - \$60,113

Reconditioned engines, deduct 20 to 30 percent.

(Photograph shown on AH 534.62, page 10)

GEAR HEADS

HP	DRIVE	SHAFT	FLANGES (2)	GUARD	LABOR	TOTAL
100	\$3,406	\$892	\$496	\$251	\$2,330	\$7,373
125	\$3,690	\$1,056	\$654	\$251	\$2,330	\$7,980
150	\$4,528	\$1,056	\$654	\$251	\$2,330	\$8,818
200	\$5,518	\$1,056	\$654	\$251	\$2,330	\$9,808
250	\$9,181	\$1,631	\$812	\$251	\$2,330	\$14,203
300	\$10,132	\$1,631	\$812	\$251	\$2,330	\$15,154
350	\$11,861	\$1,631	\$812	\$251	\$2,330	\$16,883
400	\$14,672	\$1,631	\$812	\$251	\$2,330	\$19,866

BELOW GROUND ASSEMBLY (Includes Column—Tube and Shaft and Bowls)

Gear Head HP	200' Lift	300' Lift	400' Lift	500' Lift	600' Lift	700' Lift
100	\$28,248	\$34,188				
125	\$36,498	\$42,702	\$47,388			
150	\$40,326	\$47,388	\$49,830			
200		\$51,216	\$54,054	\$57,882		
250				\$61,446	\$35,274	
300				\$64,020	\$67,878	\$71,676
400						\$76,362

Add to engine and gear head figures.

RULE OF THUMB: The horsepower of the gear head will require an engine with bulk or gross horsepower of about 1-1/2 times the size of the gear head, i.e., 200 HP gear head x 1.5 = 300 HP engine. 300 bulk HP engine x 80 percent = continuous HP x 80 percent = 192 HP to gear head.

NOTE: Costs do not include fuel tanks or fuel tank saddles.

PUMPS

DISCHARGE HEADS

<u>Discharge Size</u>	<u>Price Includes Head, Solenoid, Oiler, Column, Nipple, and Flange</u>
4" x 12"	\$2,020
6" x 12"	\$2,416
8" x 12"	\$2,495
8" x 16 ½"	\$3,128
10" x 20"	\$3,643

COLUMN ASSEMBLY (In 20' lengths)

Column	Tube	Shaft	Cost Per Foot
4"	1 1/2"	1"	\$50
6"	2"	1 1/4"	\$68
8"	2 1/2"	1 1/2"	\$82
10"	2 1/2"	1 11/16"	\$100
10"	3"	1 15/16"	\$109
12"	3"	1 15/16"	\$120
12"	3 1/2"	2 1/4"	\$134

Column assembly in 10' lengths—add 10 percent.

Reduce the above costs 10 percent for the San Joaquin Valley.

PUMPS

BOWLS

Stages	8"	10"	12"	14"	16"
1	\$2,191	\$2,653	\$3,472	\$5,122	\$7,260
2	\$2,363	\$3,274	\$4,303	\$6,244	\$7,920
3	\$2,864	\$3,894	\$5,518	\$7,577	\$12,685
4	\$3,472	\$4,686	\$6,402	\$8,804	\$12,896
5	\$4,295	\$5,320	\$7,801	\$10,758	\$15,959
6	\$4,488	\$6,244	\$8,606	\$12,487	\$18,005
7	\$4,924	\$6,983	\$9,636	\$14,230	\$20,473
8	\$5,320	\$7,788	\$10,758	\$15,959	\$22,519
9	\$6,046	\$8,672	\$12,078	\$17,200	\$25,172
10	\$6,442	\$9,016	\$12,896	\$18,942	\$27,525
11	\$7,049	\$9,834	\$14,018		
12	\$7,775	\$10,758	\$15,048		
13	\$8,171	\$11,550			
14	\$8,606	\$12,289			
15	\$9,425	\$12,896			

Reduce the above costs 10 percent for the San Joaquin Valley.

5 HP to 7 1/2 HP	Use 8" bowls
10 HP to 20 HP	Use 10" bowls
25 HP to 60 HP	Use 12" bowls
75 HP to 350 HP	Use 14" bowls up to 150' setting
8" bowls—25' per stage (100' = 4 stages)	
10" bowls—35' per stage (100' = 3 stages)	
12" bowls—50' per stage (100' = 2 stages)	
14" bowls—60' per stage (100' = 2 stages)	

CENTRIFUGAL BOOSTER PUMPS

Size	Cost
10 HP	\$4,752 - \$5,478
20 HP	\$5,940 - \$6,798
30 HP	\$7,194 - \$7,656
40 HP	\$8,118 - \$8,778
50 HP	\$9,768 - \$10,494
60 HP	\$11,550 - \$12,342
80 HP	\$13,002 - \$13,596
100 HP	\$13,992 - \$14,586

PUMPS

TURBINE BOOSTER PUMPS

Size	Cost
40 HP	\$11,484
50 HP	\$12,672
60 HP	\$14,784
75 HP	\$16,368
100 HP	\$17,556
125 HP	\$22,440
150 HP	\$24,948

SUBMERSIBLE PUMPS

Costs are based on 3-phase, 3,600 RPM pump in a 6" to 18" well. They include normal stages, check valve, power pole, control panel, and installation labor at 0' setting. Costs are relative to settings—low for shallow, high for deep—for installations typical to the horsepower. Add riser pipe and wire costs per linear foot to setting depth. Add well and casing.

HP	Motor, Pump, and Stages	Column Assembly	Recommended Well Size
5	\$3,960 to \$5,148	\$15.84 to \$21.78	8"
7 ½	\$5,148 to \$6,072	\$15.84 to \$21.78	8"
10	\$5,808 to \$6,468	\$15.84 to \$21.78	8" to 10"
15	\$6,600 to \$7,788	\$18.48 to \$25.08	10" to 12"
20	\$8,052 to \$9,108	\$18.48 to \$28.38	12"
25	\$8,580 to \$9,768	\$23.10 to \$31.02	12"
30	\$11,088 to \$12,804	\$23.10 to \$31.02	12"

High capacity—1,760 RPM (little used) for deep wells. Cost includes pump end and one stage, control panel, power pole, tax, and installation labor.

HP	Motor and Pump	Stages	Riser Pipe and Wire Per Foot	Recommended Well Size
40	\$16,368 +	\$488 per stage	\$27.72	12"
50	\$17,820 +	\$581 per stage	\$34.58	14"
60	\$12,727 +	\$634 per stage	\$34.58	14"
75	\$20,592 +	\$660 per stage	\$34.58	14"
100	\$22,176 +	\$686 per stage	\$34.58	14"

PUMPS

SUBMERSIBLE PUMPS

TAIL WATER PUMPS

HP	Cost	HP	Cost
2	\$5,280	20	\$10,296
3	\$5,544	25	\$11,088
5	\$6,072	30	\$11,484
7 ½	\$6,732	40	\$12,804
10	\$7,128	50	\$13,992
15	\$9,240		

WELLS

REVERSE ROTARY DRILLING COSTS

(Includes Casing, Gravel Pack, Cement Seal, Development of Well) Cost per foot of depth.

Size	To 700'	Over 700'	Over 1,000'
6" 12 ga.	\$48	\$78	
6" 10 ga.	\$57		
8" 12 ga.	\$65		
8" 10 ga.	\$72		
8" 3/16 in.	\$79	\$92	
10" 10 ga.	\$85		
10" 3/16 in.	\$90		
10" 1/4 in.	\$101	\$136	
12" 10 ga.	\$104		
12" 3/16 in.	\$110		
12" 1/4 in.	\$165	\$220	\$218
14" 3/16 in.	\$127		
14" 1/4 in.	\$190	\$296	\$300
14" 5/16 in.	\$202	\$325	\$325
16" 3/16 in.	\$139		
16" 1/4 in.	\$158		
16" 5/16 in.	\$231	\$380	\$380
18" 3/16 in.	\$163		
18" 1/4 in.	\$194		
18" 5/16 in.	\$304	\$433	\$433
20" 3/16 in.	\$183		
20" 1/4 in.	\$221		
20" 5/16 in.	\$420	\$493	\$493

PUMPS

WELLS

Cable Tool Drilling	Cost Per Foot of Depth
6"	\$42 - \$50
8"	\$49 - \$50
10"	\$56 - \$66
12"	\$84 - \$110
14"	\$94 - \$119
16"	\$112 - \$133
18"	\$128 - \$170

State law requires 20' seal in all well shafts.

6"	\$779
8"	\$1,204
10"	\$1,523
12"	\$1,523
14"	\$1,912
16"	\$1,912
18"	\$1,912

WINDMILLS

FAN COST INSTALLED

Wheel or Fan Diameter	Weight (Pounds)	Cost	Installation	Total
6'	200	\$3,190	\$1,430	\$4,620
8'	370	\$3,300	\$1,485	\$4,785
10'	660	\$4,785	\$1,672	\$6,127
12'	1,100	\$7,150	\$2,024	\$9,174
14'	1,700	\$10,890	\$2,310	\$13,200
16'	2,500	\$14,520	\$2,772	\$17,292

TOWER COST INSTALLED

Tower Height	Windmill Size				
	6' - 8' Fan	10' Fan	12' Fan	14' Fan	16' Fan
21'	\$2,420	\$2,750			
27'	\$3,135	\$3,630	\$4,290	\$4,400	
33'	\$3,410	\$3,850	\$4,510	\$5,170	\$6,875
40'	\$4,125	\$4,620	\$5,390	\$5,610	\$7,810
47'	\$5,198	\$6,270	\$6,270	\$7,920	\$9,570

PUMPS

WINDMILLS

Windmill installation costs are estimated by considering the following:

- Tower height
- Fan diameter
- Force pump: size and diameter
- Cylinder: size and type
- Pipe: size and length
- Rod: material, size and length.

Force pump, cylinder pipe, rod, and miscellaneous costs range from **\$1,012 to \$3,080**.

<u>Example</u>	
10' Fan	\$6,127
33' Tower	\$3,850
Force Pump, Cylinder Pipe, Rod and Miscellaneous Costs	<u>\$2,090</u>
	\$12,067

Refurbished windmill: deduct 35 to 40 percent from above prices.

PUMPS

WINDMILLS

WATER STORAGE TANKS

GALVANIZED COVERED STORAGE TANKS

Gallons	Diameter	Height	Gauge	Weight (Pounds)	Cost
1,044	6' 8"	48"	12	670	\$1,573
1,504	8' 10"	48"	12	912	\$1,953
1,900	6' 4"	96"	12	1,014	\$2,035
2,500	7' 4"	96"	12	1,321	\$2,530
2,880	7' 10"	96"	12	1,329	\$2,706
3,200	8' 3"	96"	12	1,423	\$2,893
3,500	8' 8"	96"	12	1,520	\$3,108
4,200	9' 5 1/2"	96"	12	1,724	\$3,839
5,000	10' 4"	96"	12	1,924	\$4,092
5,500	10' 10"	96"	12	2,080	\$4,532
6,000	11' 4"	96"	12	2,163	\$4,719
6,500	11' 10"	96"	12	2,210	\$5,033
7,500	10' 4"	12'	12	2,553	\$5,473
8,600	9' 7"	16'	12	2,856	\$6,039
10,000	9' 9"	18'	12	3,169	\$6,996
12,000	10' 2"	20'	12	3,667	\$7,931
15,000	11' 11"	18'	10	5,376	\$10,445
17,500	11' 2"	24'	10	5,995	\$11,638
20,000	11' 11"	24'	10	6,480	\$13,530
25,000	18' 10"	12'	10	7,320	\$16,357
30,000	20' 9"	12'	10	8,500	\$18,563

Tanks should be set on a level foundation of $\frac{3}{4}$ " crushed rock that is 4" to 6" deep.

PUMPS



TURBINE PUMP

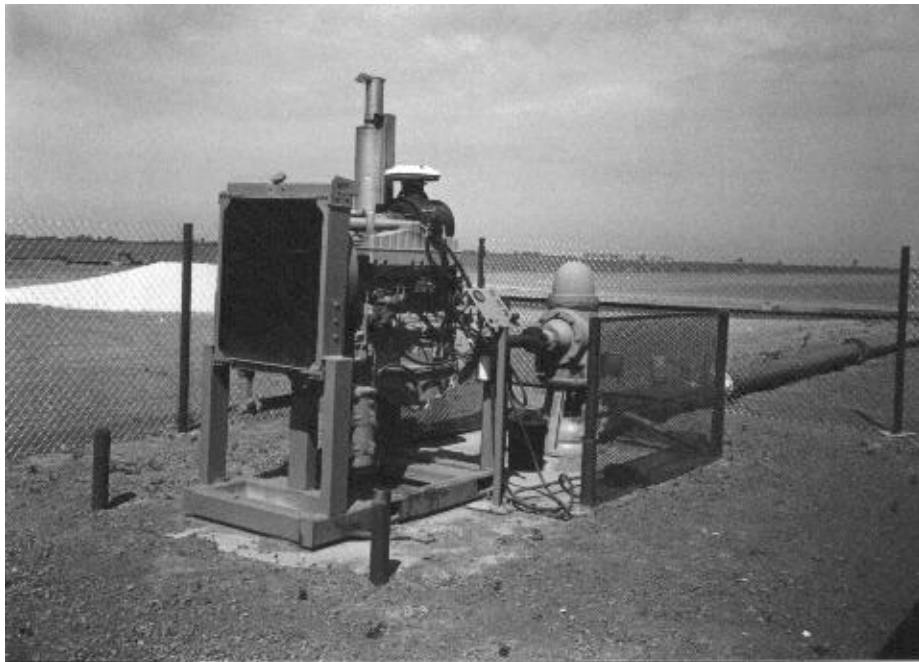

DIESEL ENGINE
WITH GEAR HEAD DRIVE

AH 534.71: CORRALS AND FENCES

This chapter contains various costs associated with corrals and fences. Specifications and costs are included for:

- Steel fencing
- Barbed wire fencing
- Wood fencing
- Wood gates
- Metal gates
- Metal panels
- Vinyl/PVC fencing
- Cattle squeeze

Photographs showing examples of equipment discussed are located at the end of the chapter.

STEEL FENCING

Height and Type	Fence Cost Per Linear Foot	Additions
<u>11 Gauge</u>		
3' chain link	\$11.42	Top Rail: \$2.32 per linear foot
4' chain link	\$12.80	
5' chain link	\$16.50	Barbed wire, 3 strands:
6' chain link	\$18.55	\$3.56 per linear foot
8' chain link	\$23.44	
10' chain link	\$28.72	Barbed coils: \$12.48 per
12' chain link	\$35.24	linear foot
<u>9 Gauge</u>		
3' chain link	\$12.94	Barbed wire, 3 strands:
4' chain link	\$13.86	\$3.77 per linear foot on
5' chain link	\$16.50	10' and 12' fence
6' chain link	\$20.20	
8' chain link	\$25.81	
10' chain link	\$32.94	
12' chain link	\$38.54	

Fences over 1,000 feet, deduct 10 percent.

CORRALS AND FENCES

BARBED WIRE FENCING

Size and Type	Cost per Linear Foot/1 Mile or More
Barbed wire, 3 strand	\$3.30 to \$4.09
Barbed wire, 4 strand	\$3.64 to \$4.36
Barbed wire, 5 strand	\$3.96 to \$4.75
2 strands barbed, 32" woven wire, steel posts	\$5.75 to \$6.34

Fence costs are complete—fencing and posts. Gates are to be added. When gates are added, continue using the total linear distance of the fence for costing and do not deduct for the linear distance of the fence replaced by the gate. Posts are set in concrete on 10' centers.

WOOD FENCING

COST PER LINEAR FOOT

Rail Size	Post Size	Number of Rails			
		1	2	3	6
2" x 8"	6" x 6"	\$10.10	\$11.69	\$14.99	\$19.01
2" x 6"	6" x 4"	\$7.79	\$8.52	\$9.18	\$11.22
2" x 4"	6" x 4"	\$7.52	\$7.99	\$8.45	\$10.10
1" x 8"	6" x 4"	\$7.26	\$8.18	\$8.71	\$10.50
1" x 6"	6" x 4"	\$6.80	\$7.39	\$8.39	\$10.06
1 ¼" x 6"	6" x 4"	\$7.00	\$7.13	\$8.78	\$10.56
2" x 6"	4" x 4"	\$7.13	\$7.66	\$8.45	\$10.16

All posts figured at 8' on center.

WOOD GATES

COST PER GATE

Height/ Description	Width						
	4'	6'	8'	10'	12'	16'	20'
4' 5 Rails	\$79	\$101	\$128	\$247	\$254	\$281	\$300
5' 6 Rails	\$100	\$119	\$190	\$268	\$288	\$311	\$330
6' 7 Rails	\$116	\$137	\$275	\$293	\$319	\$337	\$365

CORRALS AND FENCES

METAL GATES

COST PER GATE

Height/ Description	Width					
	3'	4'	10'	12'	14'	16'
4' 1 3/8" Galvanized Tube Galvanized Fabric Including Hardware	\$110	\$121	\$256	\$276	\$311	\$356
5' 1 5/8" Standard Pipe Fabric Including Hardware	\$196	\$224	\$397	\$458	\$498	\$535
6' 1 5/8" Standard Pipe Fabric Including Hardware	\$212	\$240	\$433	\$517	\$580	\$637

5-BAR ADJUSTABLE GATES—5' IN HEIGHT

Size	Cost Per Gate
3' to 4'	\$126
4' to 6'	\$139
6' to 8'	\$176
8' to 10'	\$200
10' to 12'	\$218
12' to 14'	\$260
14' to 16'	\$307
16' to 20'	\$392

6-BAR ADJUSTABLE GATES—5' IN HEIGHT

Size	Cost Per Gate
3' to 4'	\$136
4' to 6'	\$158
6' to 8'	\$202
8' to 10'	\$228
10' to 12'	\$245
12' to 14'	\$294
14' to 16'	\$308
16' to 20'	\$383

CORRALS AND FENCES

METAL PANELS

5-BAR ADJUSTABLE PANEL USED FOR STALLS OR PENS

Size	Cost Per Gate
8' to 10'	\$169
10' to 12'	\$196
12' to 14'	\$210
14' to 16'	\$245
16' to 18'	\$274
18' to 20'	\$295
20' to 22'	\$317
22' to 24'	\$325
24' to 26'	\$346

Add for the hinge and latch posts - \$47 to \$53

6-BAR ADJUSTABLE PANEL USED FOR STALLS OR PENS

Size	Cost Per Gate
8' to 10'	\$202
10' to 12'	\$224
12' to 14'	\$247
14' to 16'	\$286
16' to 18'	\$307
18' to 20'	\$352
20' to 22'	\$367
22' to 24'	\$396
24' to 26'	\$410

3-BAR FENCE PANEL

Size	Cost Per Gate
10'	\$109
12'	\$130
16'	\$149
18'	\$160
20'	\$176
24'	\$199

PORTABLE LOADING CHUTE

Size	Cost Per Gate
30" x 5' High	\$2,238

CORRALS AND FENCES

METAL PANELS

5-BAR SOLID PANEL

Size	Cost Per Gate
10'	\$160
12'	\$176
16'	\$235
18'	\$252
20'	\$274
24'	\$306

6-BAR SOLID PANEL

Size	Cost Per Gate
10'	\$175
12'	\$198
16'	\$263
18'	\$274
20'	\$304
24'	\$347

VINYL/PVC FENCING

White

Post Size	Rail Size	Number of Rails	Cost Per Linear Foot Installed
5" x 5"	1-1/2" x 5-1/2" x 16'	3	\$21.19
5" x 5"	1-1/2" x 5-1/2" x 16'	4	\$22.31

Prices based on 1,000' +

Height: 60 inches

Posts: Set in concrete—10" diameter, 30" deep, 8' on center

Gates: 12' Metal gates (preferred)—**\$984** installed, plus paint

12' PVC gates (have tendency to sag)—**\$1,552** installed

Color: Add 10 percent

(Photograph shown on AH 534.71, page 7)

CORRALS AND FENCES

CATTLE SQUEEZE

Examples may vary in cost significantly depending on manufacturer, model, and features. These listed costs are representative of models that range from economy to lower range deluxe models. High end hydraulic models produced by the highest quality manufacturers can be sold for amounts that exceed the listed costs by more than fifty percent.

Hydraulic Metal	\$13,860 to \$19,140
Upright Metal Economy Model	\$3,168 to \$3,828
Upright Metal Extended/Deluxe	\$6,336 to \$8,580
Calf Chute or Table	\$1,980 to \$2,640

(Photograph shown on AH 534.71, page 8)

CORRALS AND FENCES



VINYL FENCING

CORRALS AND FENCES



CATTLE SQUEEZE

AH 534.75: GREENHOUSES

All greenhouses are designed to provide a controlled and ideal environment in which to cultivate plants. While all greenhouses share the same objective, there are many different types of greenhouses made from various construction materials. This allows growers a great deal of freedom in choosing an appropriate configuration consistent with the needs of the plants being grown. Appropriate ventilation is important to prevent mold growth and to maintain an even temperature throughout the greenhouse. Some houses require misting systems to keep the relative humidity elevated for certain species of plants.

Commercial greenhouses are constructed with steel or wooden posts and trusses on a typical 10' center. The span of a truss is generally 20 to 40 feet. Typical commercial greenhouses use either glass or polycarbonate covers. Fiberglass or polyethylene plastic covers are cheaper alternative materials, but generally need more frequent replacement. Sometimes, a combination of materials can be used, such as glass for the exterior and polyethylene in the interior to separate plants with different environmental requirements. High quality polyethylene is also available with infrared retention and anti-condensate properties. The energy savings for this type of polyethylene can reduce heating requirements significantly. Although requiring more frequent replacement than either glass or polycarbonate, the energy savings can make this an economic choice. Additionally, the anti-condensate properties reduce incidence of plant diseases, yet another benefit of using this product.

Basic building costs shown here are for the structure only and include only those components specified. The cost of other items or equipment, such as a ventilation system or a watering system, must be added to the basic building cost to arrive at a total cost.

Photographs showing examples of greenhouse types discussed are located at the end of this chapter.

- Wall heights vary from 7 feet to 10 feet on the straight wall construction.

BUILDING SPECIFICATIONS

Components	Low Quality	Average Quality	High Quality
Wall and Roof	Light pipe, 4' wall, single light polyethylene cover, fiberglass ends	Galvanized steel frame, 8' wall, double polycarbonate or fiberglass cover	Heavy steel frame, 8' wall, glass or multi-wall polycarbonate cover
Floor	Dirt—some gravel	Gravel—some concrete walks	Adequate concrete walks, concrete foundation
Interior	No lighting, minimum water	Average lighting, water, and roof vents	Ample lighting, water, roof vents, and exhaust fans

(Photographs shown on AH 534.75, page 3)

GREENHOUSES

SQUARE-FOOT COSTS

Quality	Square-Foot Area					
	3,000-5,000	10,000	20,000	30,000	40,000	50,000
Low	\$5.50	\$4.93	\$4.80	\$4.52	\$3.98	\$3.71
Average	\$20.94	\$19.56	\$16.48	\$15.79	\$15.10	\$14.41
High	\$32.26	\$29.86	\$25.68	\$24.43	\$22.93	\$21.68

ADDITIVES

Additional concrete walk	\$4.52 to \$5.15 per square foot
Benching	\$4.25 to \$6.73 per square foot – average quality
Gravel floor	\$0.49 to \$0.62 per square foot

SHADE CLOTH HOUSES-HIGH TOWERS-HOOP HOUSES

BUILDING SPECIFICATIONS (FAIR-LOW COST)

Components	Shade Cloth House: Low/Fair Quality High Tower and Hoop house: Good Quality
Wall and Roof	Shade Cloth Houses: Wood or steel post construction, no walls, overhead cable support with wire, covered by a flat shade fabric. Normally 7 feet to 9 feet high. High Tower/Hoop House: PVC or metal pipes bent in arch with polyethylene sheet covering
Floor	Dirt
Interior	No lighting, no water

(Photographs shown on AH 534.75, page 4)

High Towers and Hoop Houses of average to good quality are in the range of value below—lower quality use 50% value

SQUARE-FOOT COSTS

Square-Foot Area	Cost Per Square Foot
Under 10,000	\$2.32 to \$2.51
10,000 – 20,000	\$1.79 to \$1.98
20,000 – 40,000	\$1.66 to \$1.85
40,000 Up	\$1.52 to \$1.79

ADDITIVE

Gravel Floor	\$0.42 to \$0.62 per square foot
--------------	----------------------------------

GREENHOUSES

CLIMATE CONTROL



GREENHOUSES

SHADE CLOTH HOUSES

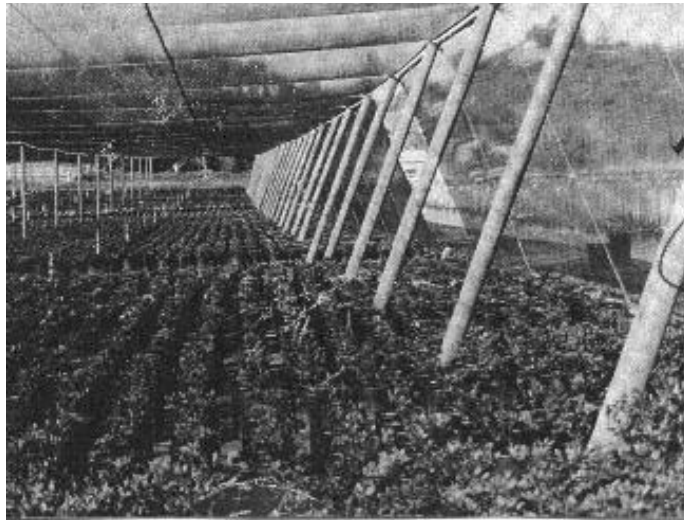
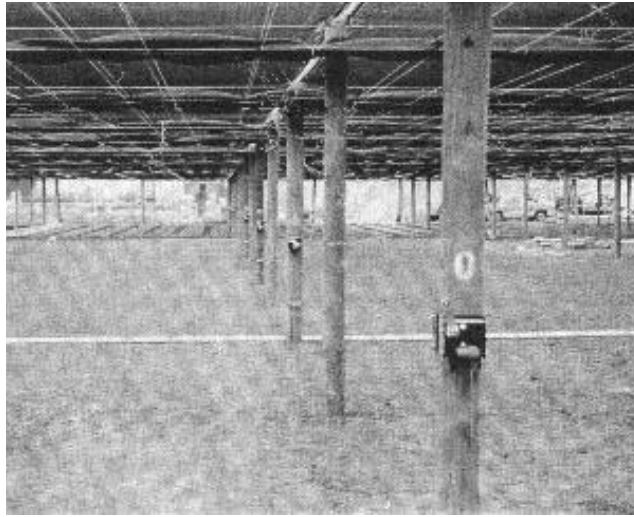

AH 534.76: LAND DEVELOPMENT AND DRAINAGE TILE

This chapter presents some of the costs incurred in the process of converting raw land to that which is suitable for its intended agricultural purpose. The land development portion provides costs for leveling of land, moving soil, and ripping of the land. The drainage portion provides drainage pipe costs to allow control of water on the land.

LAND DEVELOPMENT

LEVELING

Item	Cost per Acre
Native Land	\$385 to \$750
Ripping and Relieving	\$440 to \$700
Touch-Up Leveling—Laser	\$120 to \$150
Rescaping	\$77 to \$100

The cost of precision grading varies widely depending on the amount of soil moved, the distance the soil is moved, how far the earthmoving equipment must travel, and the costs of diesel fuel for the earthmoving equipment. Contractors charge \$100 to \$150 per hour for leveling land where the amount of soil to be moved is undetermined.

EARTH MOVING

Size	Cost
Per cubic yard	\$0.95 to \$1.25

RIPPING

Item	Cost per Acre
Clay 5' deep	\$440 to \$520
Clay 6' deep	\$440 to \$650
Loamy or sandy soil	\$275 to \$440
Hard pan 4' - 6' deep	\$460 to \$750

NOTE:

1. Ripping costs are based on four-foot centers.
2. Ripping cost with a slip plow attached to shank (superior mixing and breaking of soils) is typically done on six-foot centers, and the cost is equal to standard ripping on four-foot centers.
3. It typically takes ten hours to rip seven acres on four-foot centers.

LAND DEVELOPMENT AND DRAINAGE TILE

DRAINAGE

Modern drainage tile installations use corrugated plastic tubing. The spacing varies from 100 feet to 400 feet on centers. The older type installation includes perforated tile with wide trenches. A 5-inch corrugated plastic drain tubing is installed in a 12-inch trench versus a 24-inch to 27-inch trench for the older type installation. The cost for gravel fill is much less because of the narrower trench.

The installed cost of 5-inch corrugated plastic tubing on 400-foot centers, 7 1/2-feet deep including sump and pump, and trench width of 12 inches with gravel fill over the pipe is as follows:

DRAINAGE PIPE

Loamy soils	\$495 to \$715 per acre
Rocky soils	\$715 to \$1,105 per acre

Reduce the above cost 25 percent if system lacks a pump or sump.

Increase the above cost 25 percent if the system has 100-foot centers, with 4-inch lines.

AH 534.77: VINEYARD STAKES AND TRELLIS SYSTEMS

Vine training systems are used primarily to assist in good canopy management, which is important due to its positive effect on yield, quality, vigor, and disease prevention of grapes resulting in potential profitability for a vineyard operation.

The selection of an appropriate grape variety with a compatible trellis system is of utmost importance in the growing of grapevines. Pruning and training the grapevine on a trellis system helps a grower develop the ideal balance of vegetative growth and fruit, which can lead to higher production and better fruit quality while reducing the incidence of disease.

By managing the amount of sunlight reaching the fruit and fruiting buds, a grower can assure full ripening of the grapes during a growing season and increase chances that there will be more fruit production from fruiting buds the following year. Controlling sunlight levels in the canopy also limits sun damage to the fruit.

The ultimate selection of a grapevine trellis system depends on various factors, such as the variety of grape and whether it is a table, raisin, or wine grape. The vigor of a particular variety, soil fertility, and local climate conditions will also affect the selection. The popularity of any system may be influenced by recent research and studies or even by word of mouth among growers.

This chapter contains costs for various stake and trellis systems used in the production of table, raisin, and wine grapes. Miscellaneous vineyard component costs are also provided for the following:

- Wire price per acre
- Metal stakes and cross-arms
- Wood stakes and cross-arms
- Deer fence

Vineyard stakes and trellis costs can vary significantly due to differences in the following:

- Nature and quality of material
- Spacing between the rows of vines
- Type of vineyard
- Cost of labor (farm labor or commercial contractor)

The Useful Information page at the end of this chapter contains a conversion chart for wire sizes, along with a chart for the spacing of plants and an estimate of the amount of wire required.

Photographs showing examples of the improvements discussed are located at the end of this chapter.

VINEYARD STAKES AND TRELLIS SYSTEMS

TABLE GRAPES

SINGLE CROSS-ARM

10 FOOT ROWS

	Spacing—6' x 10' or 7' x 10' or 8' x 10'		
	Cost Per Unit	Posts Per Acre	Cost Per Acre
Post and cross-arm assembly	\$7.48		
Every 15 feet	\$7.48	290	\$2,169
Every 18 feet	\$7.48	242	\$1,810
Every 21 feet	\$7.48	207	\$1,549
Every 24 feet	\$7.48	182	\$1,361
Four wires			\$502
End post with anchor (installed)	\$42.90	14	\$601
End post without anchor (installed)	\$33.00	14	\$462

11 FOOT ROWS

	Spacing—6' x 11' or 7' x 11' or 8' x 11'		
	Cost Per Unit	Posts Per Acre	Cost Per Acre
Post and cross-arm assembly	\$7.48		
Every 15 feet	\$7.48	264	\$1,975
Every 18 feet	\$7.48	220	\$1,646
Every 21 feet	\$7.48	188	\$1,406
Every 24 feet	\$7.48	165	\$1,234
Four wires			\$464
End post with anchor (installed)	\$42.90	13	\$558
End post without anchor (installed)	\$33.00	13	\$429

12 FOOT ROWS

	Spacing—6' x 12' or 7' x 12' or 8' x 12'		
	Cost Per Unit	Posts Per Acre	Cost Per Acre
Post and cross-arm assembly	\$7.48		
Every 15 feet	\$7.48	242	\$1,810
Every 18 feet	\$7.48	201	\$1,503
Every 21 feet	\$7.48	172	\$1,287
Every 24 feet	\$7.48	151	\$1,129
Four wires			\$410
End post with anchor (installed)	\$42.90	12	\$515
End post without anchor (installed)	\$33.00	12	\$396

Based on 600 foot rows.

(Photographs shown on AH 534.77, page 17)

VINEYARD STAKES AND TRELLIS SYSTEMS

TABLE GRAPES

DOUBLE CROSS-ARM

10 FOOT ROWS

	Spacing—6' x 10' or 7' x 10' or 8' x 10'		
	Cost Per Unit	Posts Per Acre	Cost Per Acre
Post and cross-arm assembly	\$8.91		
Every 15 feet	\$8.91	290	\$2,584
Every 18 feet	\$8.91	242	\$2,156
Every 21 feet	\$8.91	207	\$1,844
Every 24 feet	\$8.91	182	\$1,622
Six wires			\$751
End post with anchor (installed)	\$42.90	14	\$601
End post without anchor (installed)	\$33.00	14	\$462

11 FOOT ROWS

	Spacing—6' x 11' or 7' x 11' or 8' x 11'		
	Cost Per Unit	Posts Per Acre	Cost Per Acre
Post and cross-arm assembly	\$8.91		
Every 15 feet	\$8.91	264	\$2,352
Every 18 feet	\$8.91	220	\$1,960
Every 21 feet	\$8.91	188	\$1,675
Every 24 feet	\$8.91	165	\$1,470
Six wires			\$683
End post with anchor (installed)	\$42.90	13	\$558
End post without anchor (installed)	\$33.00	13	\$429

12 FOOT ROWS

	Spacing—6' x 12' or 7' x 12' or 8' x 12'		
	Cost Per Unit	Posts Per Acre	Cost Per Acre
Post and cross-arm assembly	\$8.91		
Every 15 feet	\$8.91	242	\$2,156
Every 18 feet	\$8.91	201	\$1,791
Every 21 feet	\$8.91	172	\$1,533
Every 24 feet	\$8.91	151	\$1,345
Six wires			\$630
End post with anchor (installed)	\$42.90	12	\$515
End post without anchor (installed)	\$33.00	12	\$396

Based on 600 foot rows.

(Photographs shown on AH 534.77, page 18)

VINEYARD STAKES AND TRELLIS SYSTEMS

TABLE GRAPES/RAISINS

OPEN GABLE TRELLIS

10 FOOT ROWS

	Spacing—6' x 10' or 7' x 10' or 8' x 10'		
	Cost Per Unit	Posts Per Acre	Cost Per Acre
Post and cross-arm assembly	\$15.40		
Every 18 feet	\$15.40	242	\$3,727
Every 21 feet	\$15.40	207	\$3,188
Every 24 feet	\$15.40	192	\$2,803
Six wires			\$753
Eight wires			\$1,003
End post with anchor (installed)	\$42.90	14	\$601

11 FOOT ROWS

	Spacing—6' x 11' or 7' x 11' or 8' x 11'		
	Cost Per Unit	Posts Per Acre	Cost Per Acre
Post and cross-arm assembly	\$15.40		
Every 18 feet	\$15.40	220	\$3,388
Every 21 feet	\$15.40	188	\$2,895
Every 24 feet	\$15.40	165	\$2,541
Six wires			\$685
Eight wires			\$910
End post with anchor (installed)	\$42.90	13	\$558

12 FOOT ROWS

	Spacing—6' x 12' or 7' x 12' or 8' x 12'		
	Cost Per Unit	Posts Per Acre	Cost Per Acre
Post and cross-arm assembly	\$15.40		
Every 18 feet	\$15.40	201	\$3,095
Every 21 feet	\$15.40	172	\$2,649
Every 24 feet	\$15.40	151	\$2,325
Six wires			\$628
Eight wires			\$836
End post with anchor (installed)	\$42.90	12	\$515

Based on 600 foot rows.

(Photographs shown on AH 534.77, page 19)

VINEYARD STAKES AND TRELLIS SYSTEMS

RAISIN GRAPES

TRELLIS

10 FOOT ROWS

	Cost Per Unit	Posts Per Acre	Cost Per Acre		
			5' x 10'	6' x 10'	7' x 10'
Light 7' stake and 24" cross-arm	\$6.44				
Every 5 feet	\$6.44	871	\$5,609		
Every 6 feet	\$6.44	726		\$4,675	
Every 7 feet	\$6.44	622			\$4,006
Two wires			\$255	\$255	\$255
End post	\$33.00	14	\$462	\$462	\$462
Light 7' stake with no cross-arm	\$4.46		\$3,885	\$3,238	\$2,774
One wire			\$128	\$128	\$128

11 FOOT ROWS

	Cost Per Unit	Posts Per Acre	Cost Per Acre		
			5' x 11'	6' x 11'	7' x 11'
Light 7' stake and 24" cross-arm	\$6.44				
Every 5 feet	\$6.44	792	\$5,100		
Every 6 feet	\$6.44	660		\$4,250	
Every 7 feet	\$6.44	566			\$3,645
Two wires			\$231	\$231	\$231
End post	\$33.00	13	\$429	\$429	\$429
Light 7' stake with no cross-arm	\$4.46		\$3,532	\$2,944	\$2,524
One wire			\$116	\$116	\$116

12 FOOT ROWS

	Cost Per Unit	Posts Per Acre	Cost Per Acre		
			5' x 12'	6' x 12'	7' x 12'
Light 7' stake and 24" cross-arm	\$6.44				
Every 5 feet	\$6.44	726	\$4,675		
Every 6 feet	\$6.44	605		\$3,896	
Every 7 feet	\$6.44	518			\$3,336
Two wires			\$194	\$194	\$194
End post	\$33.00	12	\$396	\$396	\$396
Light 7' stake with no cross-arm	\$4.46		\$3,238	\$2,698	\$2,310
One wire			\$97	\$97	\$97

(Drawing and photograph shown on AH 534.77, page 20)

VINEYARD STAKES AND TRELLIS SYSTEMS

RAISIN GRAPES

OVERHEAD DRY ON VINE TRELLIS

Commonly used in 12' rows with 6' between vines; occasionally used on 10' and 11' rows; and to a lesser extent on 8' and 9' rows.

Materials: Wood post 12' on ends, 9' on sides, 10' wood post every third vine with 36" cross-arm, 8 wires per row, and cable support.

Trellising Cost Per Acre:

\$6,160 to \$6,600 on 6' x 12' spacing

\$6,600 to \$7,370 on 10' and 11' rows

\$7,260 to \$8,580 on 8' and 9' rows

(Drawing and photograph shown on AH 534.77, page 21)

T-POST DRY ON VINE TRELLIS

T-Posts:

V8' T-post every 28' with two 10' cross-arms and 5 wires. In between T-posts are 2 bent 7' to 8' T-posts with 2 wires. Each vine will have a training stake.

Each end has a heavy steel post with anchors.

Cost: **\$3,135 to \$3,795** for 7' x 12' spacing.

(Photographs shown on AH 534.77, page 22)

VINEYARD STAKES AND TRELLIS SYSTEMS

WINE GRAPES

TRELLIS

6 FOOT ROWS

	Cost Per Unit	Vines Per Acre		
		1,815	1,452	1,210
		Cost Per Acre		
		4' x 6'	5' x 6'	6' x 6'
22 end posts per acre with anchor	\$43	\$946	\$946	\$946
22 end posts per acre without anchor	\$33	\$726	\$726	\$726
7' Light T-post (Add 30% for heavy T-post)				
Every vine	\$4.13	\$7,496	\$5,997	\$4,997
Every other vine	\$2.09	\$3,793	\$3,035	\$2,529
Every third vine	\$1.38	\$2,505	\$2,004	\$1,670
Every fourth vine	\$1.03	\$1,869	\$1,496	\$1,246
8' Vertical line post (13 ga.)				
Every vine	\$8.86	\$16,081	\$12,865	\$10,721
Every other vine	\$4.43	\$8,040	\$6,432	\$5,360
Every third vine	\$2.95	\$5,354	\$4,283	\$3,570
Every fourth vine	\$2.20	\$3,993	\$3,194	\$2,662
4' Rebar or pencil rod at each vine (between T-post or vertical line)	\$0.79			
One rebar between posts	\$0.40	\$726	\$581	\$484
Two rebars between posts	\$0.53	\$962	\$770	\$641
Three rebars between posts	\$0.59	\$1,071	\$857	\$714
24" cross-arm (Add 25% for 30" cross-arm)				
Every vine	\$2.04	\$3,703	\$2,962	\$2,468
Every other vine	\$1.02	\$1,851	\$1,481	\$1,234
Every third vine	\$0.68	\$1,234	\$987	\$823
Every fourth vine	\$0.51	\$926	\$741	\$617
Two wires		\$399	\$399	\$399
Three wires		\$600	\$600	\$600
Four wires		\$800	\$800	\$800
Five wires		\$1,001	\$1,001	\$1,001
Six wires		\$1,202	\$1,202	\$1,202
Seven wires		\$1,402	\$1,402	\$1,402
Eight wires		\$1,601	\$1,601	\$1,601

(Photographs shown on AH 534.77, pages 23-28)

VINEYARD STAKES AND TRELLIS SYSTEMS

WINE GRAPES

TRELLIS

7 FOOT ROWS

	Cost Per Unit	Vines Per Acre			
		1,555	1,245	1,037	889
		Cost Per Acre			
		4' x 7'	5' x 7'	6' x 7'	7' x 7'
20 end posts per acre with anchor	\$43	\$860	\$860	\$860	\$860
20 end posts per acre without anchor	\$33	\$660	\$660	\$660	\$660
7' Light T-post (Add 30% for heavy T-post)					
Every vine	\$4.13	\$6,422	\$5,142	\$4,283	\$3,672
Every other vine	\$2.09	\$3,250	\$2,602	\$2,167	\$1,858
Every third vine	\$1.38	\$2,146	\$1,718	\$1,431	\$1,227
Every fourth vine	\$1.03	\$1,602	\$1,282	\$1,068	\$916
8' Vertical line post (13 ga.)					
Every vine	\$8.86	\$13,777	\$11,031	\$9,188	\$7,877
Every other vine	\$4.43	\$6,889	\$5,515	\$4,594	\$3,938
Every third vine	\$2.95	\$4,587	\$3,673	\$3,059	\$2,623
Every fourth vine	\$2.20	\$3,421	\$2,739	\$2,281	\$1,956
4' Rebar or pencil rod at each vine (between T-post or vertical line)	\$0.79				
One rebar between posts	\$0.40	\$622	\$498	\$415	\$356
Two rebars between posts	\$0.53	\$824	\$660	\$550	\$471
Three rebars between posts	\$0.59	\$917	\$735	\$612	\$525
24" cross-arm (Add 25% for 30" cross-arm)					
Every vine	\$2.04	\$3,172	\$2,540	\$2,115	\$1,814
Every other vine	\$1.02	\$1,586	\$1,270	\$1,058	\$907
Every third vine	\$0.68	\$1,057	\$847	\$705	\$605
Every fourth vine	\$0.51	\$793	\$635	\$529	\$453
Two wires		\$340	\$340	\$340	\$340
Three wires		\$516	\$516	\$516	\$516
Four wires		\$687	\$687	\$687	\$687
Five wires		\$859	\$859	\$859	\$859
Six wires		\$1,029	\$1,029	\$1,029	\$1,029
Seven wires		\$1,201	\$1,201	\$1,201	\$1,201
Eight wires		\$1,360	\$1,360	\$1,360	\$1,360

(Photographs shown on AH 534.77, pages 23-28)

VINEYARD STAKES AND TRELLIS SYSTEMS

WINE GRAPES

TRELLIS

8 FOOT ROWS

	Cost Per Unit	Vines Per Acre			
		1,089	907	778	681
		Cost Per Acre			
		5' x 8'	6' x 8'	7' x 8'	8' x 8'
18 end posts per acre with anchor	\$43	\$774	\$774	\$774	\$774
18 end posts per acre without anchor	\$33	\$594	\$594	\$594	\$594
7' Light T-post (Add 30% for heavy T-post)					
Every vine	\$4.13	\$4,498	\$3,746	\$3,213	\$2,813
Every other vine	\$2.09	\$2,276	\$1,896	\$1,626	\$1,423
Every third vine	\$1.38	\$1,503	\$1,252	\$1,074	\$940
Every fourth vine	\$1.03	\$1,122	\$934	\$801	\$701
8' Vertical line post (13 ga.)					
Every vine	\$8.86	\$9,649	\$8,036	\$6,893	\$6,034
Every other vine	\$4.43	\$4,824	\$4,018	\$3,447	\$3,017
Every third vine	\$2.95	\$3,213	\$2,676	\$2,295	\$2,009
Every fourth vine	\$2.20	\$2,396	\$1,995	\$1,712	\$1,498
4' Rebar or pencil rod at each vine (between T-post or vertical line)	\$0.79				
One rebar between posts	\$0.40	\$436	\$363	\$311	\$272
Two rebars between posts	\$0.53	\$577	\$481	\$412	\$361
Three rebars between posts	\$0.59	\$643	\$535	\$459	\$402
24" cross-arm (Add 25% for 30" cross-arm)					
Every vine	\$2.04	\$2,222	\$1,850	\$1,587	\$1,389
Every other vine	\$1.02	\$1,111	\$925	\$794	\$695
Every third vine	\$0.68	\$741	\$617	\$529	\$463
Every fourth vine	\$0.51	\$555	\$463	\$397	\$347
Two wires		\$302	\$302	\$302	\$302
Three wires		\$453	\$453	\$453	\$453
Four wires		\$601	\$601	\$601	\$601
Five wires		\$752	\$752	\$752	\$752
Six wires		\$904	\$904	\$904	\$904
Seven wires		\$1,055	\$1,055	\$1,055	\$1,055
Eight wires		\$1,203	\$1,203	\$1,203	\$1,203

(Photographs shown on AH 534.77, pages 23-28)

VINEYARD STAKES AND TRELLIS SYSTEMS

WINE GRAPES

TRELLIS

9 FOOT ROWS

	Cost Per Unit	Vines Per Acre			
		968	807	691	605
		Cost Per Acre			
		5' x 9'	6' x 9'	7' x 9'	8' x 9'
16 end posts per acre with anchor	\$43	\$688	\$688	\$688	\$688
16 end posts per acre without anchor	\$33	\$528	\$528	\$528	\$528
7' Light T-post (Add 30% for heavy T-post)					
Every vine	\$4.13	\$3,998	\$3,333	\$2,854	\$2,499
Every other vine	\$2.09	\$2,023	\$1,687	\$1,444	\$1,265
Every third vine	\$1.38	\$1,336	\$1,111	\$954	\$835
Every fourth vine	\$1.03	\$997	\$831	\$712	\$623
8' Vertical line post (13 ga.)					
Every vine	\$8.86	\$8,576	\$7,150	\$6,122	\$5,360
Every other vine	\$4.43	\$4,288	\$3,575	\$3,061	\$2,680
Every third vine	\$2.95	\$2,856	\$2,381	\$2,038	\$1,785
Every fourth vine	\$2.20	\$2,130	\$1,775	\$1,520	\$1,331
4' Rebar or pencil rod at each vine (between T-post or vertical line)	\$0.79				
One rebar between posts	\$0.40	\$387	\$323	\$276	\$242
Two rebars between posts	\$0.53	\$513	\$428	\$366	\$321
Three rebars between posts	\$0.59	\$571	\$476	\$408	\$357
24" cross-arm (Add 25% for 30" cross-arm)					
Every vine	\$2.04	\$1,975	\$1,646	\$1,410	\$1,234
Every other vine	\$1.02	\$987	\$823	\$705	\$617
Every third vine	\$0.68	\$658	\$549	\$470	\$411
Every fourth vine	\$0.51	\$494	\$412	\$352	\$309
Two wires		\$285	\$285	\$285	\$285
Three wires		\$425	\$425	\$425	\$425
Four wires		\$569	\$569	\$569	\$569
Five wires		\$712	\$712	\$712	\$712
Six wires		\$854	\$854	\$854	\$854
Seven wires		\$998	\$998	\$998	\$998
Eight wires		\$1,214	\$1,214	\$1,214	\$1,214

(Photographs shown on AH 534.77, pages 23-28)

VINEYARD STAKES AND TRELLIS SYSTEMS

WINE GRAPES

TRELLIS

10 FOOT ROWS

	Cost Per Unit	Vines Per Acre			
		871	726	622	544
		Cost Per Acre			
		5' x 10'	6' x 10'	7' x 10'	8' x 10'
14 end posts per acre with anchor	\$43	\$602	\$602	\$602	\$602
14 end posts per acre without anchor	\$33	\$462	\$462	\$462	\$462
7' Light T-post (Add 30% for heavy T-post)					
Every vine	\$4.13	\$3,597	\$2,998	\$2,569	\$2,247
Every other vine	\$2.09	\$1,820	\$1,517	\$1,300	\$1,137
Every third vine	\$1.38	\$1,202	\$1,002	\$858	\$751
Every fourth vine	\$1.03	\$897	\$748	\$641	\$560
8' Vertical line post (13 ga.)					
Every vine	\$8.86	\$7,717	\$6,432	\$5,511	\$4,820
Every other vine	\$4.43	\$3,859	\$3,216	\$2,755	\$2,410
Every third vine	\$2.95	\$2,569	\$2,142	\$1,835	\$1,605
Every fourth vine	\$2.20	\$1,916	\$1,597	\$1,368	\$1,197
4' Rebar or pencil rod at each vine (between T-post or vertical line)	\$0.79				
One rebar between posts	\$0.40	\$348	\$290	\$249	\$218
Two rebars between posts	\$0.53	\$462	\$385	\$330	\$288
Three rebars between posts	\$0.59	\$514	\$428	\$367	\$321
24" cross-arm (Add 25% for 30" cross-arm)					
Every vine	\$2.04	\$1,777	\$1,481	\$1,269	\$1,110
Every other vine	\$1.02	\$888	\$741	\$634	\$555
Every third vine	\$0.68	\$592	\$494	\$423	\$370
Every fourth vine	\$0.51	\$444	\$370	\$317	\$277
Two wires		\$255	\$255	\$255	\$255
Three wires		\$383	\$383	\$383	\$383
Four wires		\$512	\$512	\$512	\$512
Five wires		\$612	\$612	\$612	\$612
Six wires		\$768	\$768	\$768	\$768
Seven wires		\$896	\$896	\$896	\$896
Eight wires		\$1,023	\$1,023	\$1,023	\$1,023

(Photographs shown on AH 534.77, pages 23-28)

VINEYARD STAKES AND TRELLIS SYSTEMS

WINE GRAPES

TRELLIS

11 FOOT ROWS

	Cost Per Unit	Vines Per Acre			
		792	660	566	495
		Cost Per Acre			
		5' x 11'	6' x 11'	7' x 11'	8' x 11'
13 end posts per acre with anchor	\$43	\$559	\$559	\$559	\$559
13 end posts per acre without anchor	\$33	\$429	\$429	\$429	\$429
7' Light T-post (Add 30% for heavy T-post)					
Every vine	\$4.13	\$3,271	\$2,726	\$2,338	\$2,044
Every other vine	\$2.09	\$1,655	\$1,379	\$1,183	\$1,035
Every third vine	\$1.38	\$1,093	\$911	\$781	\$683
Every fourth vine	\$1.03	\$816	\$680	\$583	\$510
8' Vertical line post (13 ga.)					
Every vine	\$8.86	\$7,017	\$5,848	\$5,015	\$4,386
Every other vine	\$4.43	\$3,509	\$2,924	\$2,507	\$2,193
Every third vine	\$2.95	\$2,336	\$1,947	\$1,670	\$1,460
Every fourth vine	\$2.20	\$1,742	\$1,452	\$1,245	\$1,089
4' Rebar or pencil rod at each vine (between T-post or vertical line)	\$0.79				
One rebar between posts	\$0.40	\$317	\$264	\$226	\$198
Two rebars between posts	\$0.53	\$420	\$350	\$300	\$262
Three rebars between posts	\$0.59	\$467	\$389	\$334	\$292
24" cross-arm (Add 25% for 30" cross-arm)					
Every vine	\$2.04	\$1,616	\$1,346	\$1,155	\$1,010
Every other vine	\$1.02	\$808	\$673	\$577	\$505
Every third vine	\$0.68	\$539	\$449	\$385	\$337
Every fourth vine	\$0.51	\$404	\$337	\$289	\$252
Two wires		\$232	\$232	\$232	\$232
Three wires		\$350	\$350	\$350	\$350
Four wires		\$463	\$463	\$463	\$463
Five wires		\$579	\$579	\$579	\$579
Six wires		\$698	\$698	\$698	\$698
Seven wires		\$814	\$814	\$814	\$814
Eight wires		\$929	\$929	\$929	\$929

(Photographs shown on AH 534.77, page 23-28)

VINEYARD STAKES AND TRELLIS SYSTEMS

WINE GRAPES

LYRE SYSTEM

11 FOOT ROWS

	Cost Per Unit	Vines Per Acre			
		792	660	566	495
		Cost Per Acre			
		5' x 11'	6' x 11'	7' x 11'	8' x 11'
13 end posts per acre with anchor	\$43	\$559	\$559	\$559	\$559
13 end posts per acre without anchor	\$33	\$429	\$429	\$429	\$429
Heavy steel stake with open lyre cross-arm					
Every vine	\$17.16				
Every other vine	\$8.58	\$6,795	\$5,663	\$4,856	\$4,247
Every third vine	\$5.72	\$4,530	\$3,775	\$3,238	\$2,831
Every fourth vine	\$4.29	\$3,398	\$2,831	\$2,428	\$2,124
4' Rebar or pencil rod at each vine (between lyre cross-arm)	\$0.79				
One rebar between lyres	\$0.40	\$317	\$264	\$226	\$198
Two rebars between lyres	\$0.53	\$420	\$350	\$300	\$262
Three rebars between lyres	\$0.59	\$467	\$389	\$334	\$292
Six wires		\$698	\$698	\$698	\$698
Seven wires		\$814	\$814	\$814	\$814
Eight wires		\$929	\$929	\$929	\$929
Nine wires		\$1,043	\$1,043	\$1,043	\$1,043
Ten wires		\$1,159	\$1,159	\$1,159	\$1,159

(Drawing and photograph shown on AH 534.77, page 25)

VINEYARD STAKES AND TRELLIS SYSTEMS

WINE GRAPES

LYRE SYSTEM

12 FOOT ROWS

	Cost Per Unit	Vines Per Acre			
		726	605	518	454
		Cost Per Acre			
		5' x 12'	6' x 12'	7' x 12'	8' x 12'
12 end posts per acre with anchor	\$43	\$516	\$516	\$516	\$516
12 end posts per acre without anchor	\$33	\$396	\$396	\$396	\$396
Heavy steel stake with open lyre cross-arm					
Every vine	\$17.16				
Every other vine	\$8.58	\$6,229	\$5,191	\$4,444	\$3,895
Every third vine	\$5.72	\$4,153	\$3,461	\$2,963	\$2,597
Every fourth vine	\$4.29	\$3,115	\$2,595	\$2,222	\$1,948
4' Rebar or pencil rod at each vine (between lyre cross-arm)	\$0.79				
One rebar between lyres	\$0.40	\$290	\$242	\$207	\$182
Two rebars between lyres	\$0.53	\$385	\$321	\$275	\$241
Three rebars between lyres	\$0.59	\$428	\$357	\$306	\$268
Six wires		\$638	\$638	\$638	\$638
Seven wires		\$748	\$748	\$748	\$748
Eight wires		\$854	\$854	\$854	\$854
Nine wires		\$960	\$960	\$960	\$960
Ten wires		\$1,059	\$1,059	\$1,059	\$1,059

(Drawing and photograph shown on AH 534.77, page 25)

VINEYARD STAKES AND TRELLIS SYSTEMS

MISCELLANEOUS

COMPONENT COSTS TO CALCULATE COSTS PER ACRE

WIRE PRICE PER ACRE

Based on 10' spacing between rows of vines and 13 gauge wire	
2 wire	\$275
3 wire	\$414
4 wire	\$552
5 wire	\$691
6 wire	\$828

METAL STAKES AND CROSS-ARMS

T-Post Stakes and Training Stakes		Metal Cross-arms With U Bolts (Medium Grade)	
7' .95 lbs/ft	\$4.06	6"	\$0.98
7' 1.25 lbs/ft	\$5.04	12"	\$1.11
6' .95 lbs/ft	\$3.47	18"	\$1.54
6' 1.25 lbs/ft	\$4.30	24"	\$1.97
5' .95 lbs/ft	\$2.88	30" to 34"	\$2.79
4' Rebar Training Stake	\$0.77	36"	\$2.93
4' ¼" Steel Training Stake	\$0.65	48"	\$3.92

Heavy duty elaborate galvanized cross-arms can run 40 to 50 percent more.

WOOD STAKES AND CROSS-ARMS

Stakes			Cross-arms With Clips		Cross-arms With U-Bolts	
5'	1 ¾" sq	\$1.78	12"	\$0.62	12"	\$0.65 - \$0.74
6'	1 ¾" sq	\$2.16	24"	\$0.80	24"	\$0.99 - \$1.23
7'	1 ¾" sq	\$2.59	30"	\$0.92	30"	\$1.17 - \$1.30
8'	3" to 4"	\$4.74 - \$6.09	36"	\$1.17	36"	\$1.30 - \$1.41

Price varies with quality

4' Pencil rod and rebar **\$0.75 to \$0.84** each

T-post with J.R. wire clips
7' heavy T-post: **\$5.39** installed
7' light T-post: **\$4.13** installed

Vertical line post with wire slots
8' Vertical line post (13 ga.): **\$8.86** installed
J.R. clips: **\$0.35** each

Steel end post with spade
\$27.50 to \$28.60 each
\$3.85 install

Screw-in earth anchor
6" x 48" : **\$8.28** 6" x 36" : **\$7.39**
\$5.28 install

(Photographs shown on AH 534.77, page 26, 27, and 28)

7' Deer fence made with 9' T-post and 9' wood stakes
6 ½' woven wire with 2 barbed wires on top and steel gates at drives
Cost: **\$5.39 to \$6.99** per linear foot

(Photographs shown on AH 534.77, page 29)

VINEYARD STAKES AND TRELLIS SYSTEMS

USEFUL INFORMATION

WIRE

10 Gauge	2,060 ft. Per 100 lbs. roll
11 Gauge	2,580 ft. Per 100 lbs. roll
12 Gauge	3,370 ft. Per 100 lbs. roll
13 Gauge	4,470 ft. Per 100 lbs. roll
14 Gauge	5,860 ft. Per 100 lbs. roll

PLANTING SPACING AND WIRE CHART

Planting Pattern Between Plants—Between Rows	One-Wire System No. of Wire Feet Required Per Acre	No. of Plants Required Per Acre
3' x 6'	7,260'	2,420
4' x 6'	7,260'	1,815
5' x 6'	7,260'	1,452
6' x 6'	7,260'	1,210
3' x 7'	6,222'	2,074
4' x 7'	6,222'	1,555
5' x 7'	6,222'	1,245
6' x 7'	6,222'	1,037
7' x 7'	6,222'	889
3' x 8'	5,445'	1,815
4' x 8'	5,445'	1,361
5' x 8'	5,445'	1,089
6' x 8'	5,445'	907
7' x 8'	5,445'	778
8' x 8'	5,445'	681
3' x 9'	4,850'	1,613
4' x 9'	4,850'	1,210
5' x 9'	4,850'	968
6' x 9'	4,850'	807
7' x 9'	4,850'	691
8' x 9'	4,850'	605
5' x 10'	4,355'	871
6' x 10'	4,356'	726
7' x 10'	4,354'	622
8' x 10'	4,352'	544
5' x 11'	3,960'	792
6' x 11'	3,960'	660
7' x 11'	3,962'	566
8' x 11'	3,960'	495
5' x 12'	3,630'	726
5½' x 12'	3,630'	660
6' x 12'	3,630'	605
7' x 12'	3,626'	518
8' x 12'	3,632'	454

VINEYARD STAKES AND TRELLIS SYSTEMS

TABLE GRAPES

SINGLE CROSS-ARM



Seven-foot stake and 36" to 42" cross-arm with four wires (13-gauge)



VINEYARD STAKES AND TRELLIS SYSTEMS

TABLE GRAPES

DOUBLE CROSS-ARM



Seven-foot stake, 42" top cross-arm, 24" to 30" lower cross-arm, with six wires (13-gauge)



VINEYARD STAKES AND TRELLIS SYSTEMS

TABLE GRAPES/RAISINS

OPEN GABLE TRELLISES



Eight-foot steel post, 4' angle iron on each side of post forming V with the tops approximately 6' to 7' apart, with 3 to 4 wires (13-gauge) on each side



VINEYARD STAKES AND TRELLIS SYSTEMS

RAISIN GRAPES

VERTICAL TRELLIS

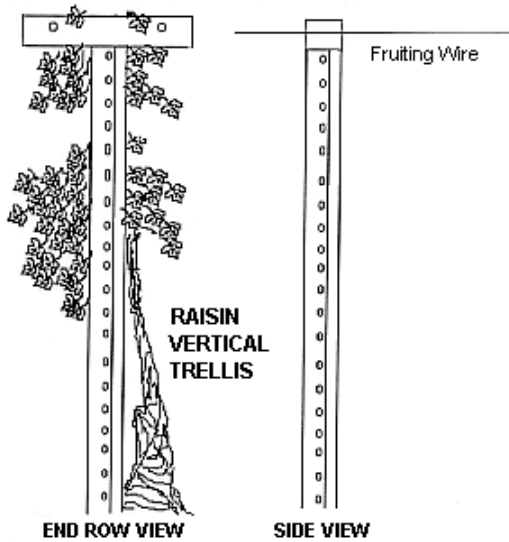

Commonly used for raisins with 12' spacing.

Materials: 8' wooden end posts with 7' medium T stakes at each vine. A single 24" metal cross-arm with two 13-gauge wires.



VINEYARD STAKES AND TRELLIS SYSTEMS

RAISIN GRAPES

OVERHEAD DRY ON VINE TRELLIS

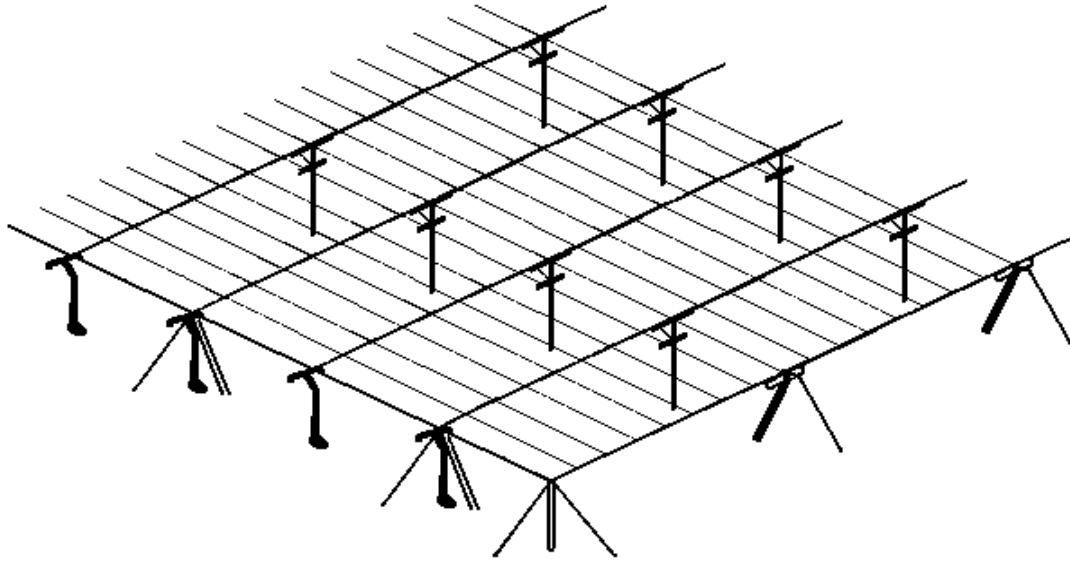

Commonly used in 12' row with 6' between vines; occasionally used on 10' and 11' rows; a few 8' and 9' rows.

Materials: Wood post 12' on ends, 9' on sides, 10' wood post every third vine with 36" cross-arm, 8 wires per row, and cable support.

VINEYARD STAKES AND TRELLIS SYSTEMS

RAISIN GRAPES

SUN MAID SOUTHSIDE DRY ON VINE TRELLIS



8' T-post every 28' with two 10' cross-arms and 5 wires. In between T-posts are 2 bent 7' to 8' T-posts with 2 wires. Each vine will have a training stake. Each end has a heavy steel post with anchors.



VINEYARD STAKES AND TRELLIS SYSTEMS

WINE GRAPES

TRELLIS



T-post with cross-arm every vine



T-post and V cross-arm

VINEYARD STAKES AND TRELLIS SYSTEMS

WINE GRAPES

TRELLIS



8' vertical line post with 4' T-posts in between



8' vertical line post with light grape stakes in between

VINEYARD STAKES AND TRELLIS SYSTEMS

WINE GRAPES

LYRE TRELLIS

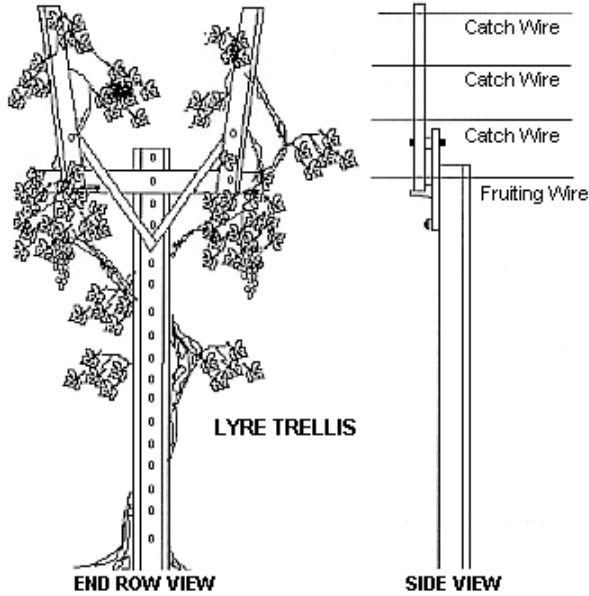

Commonly used in wide row of 11' to 12'.

Materials: Heavy steel or wood end posts; heavy and medium T stakes with anchor plates; 8' to 12' gauge wires on metal open Lyre cross-arms with a typical width of 42" at the top; 6 to 10 wires.



VINEYARD STAKES AND TRELLIS SYSTEMS

MISCELLANEOUS

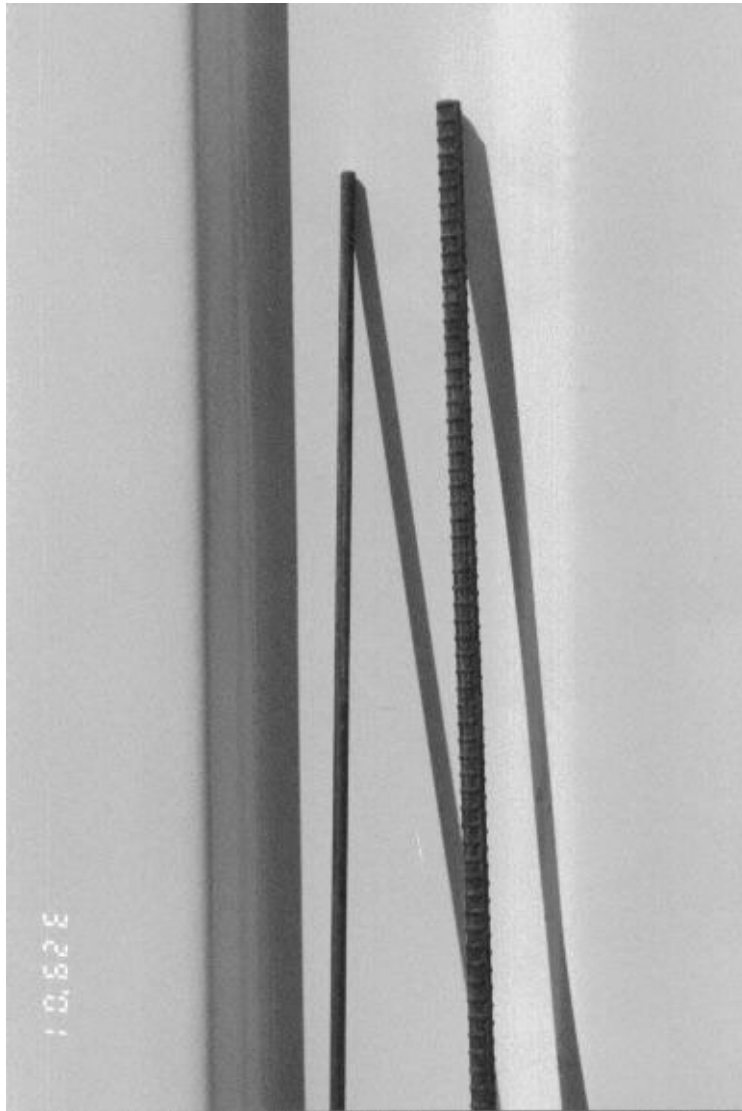

4' Pencil rod and rebar

VINEYARD STAKES AND TRELLIS SYSTEMS

MISCELLANEOUS

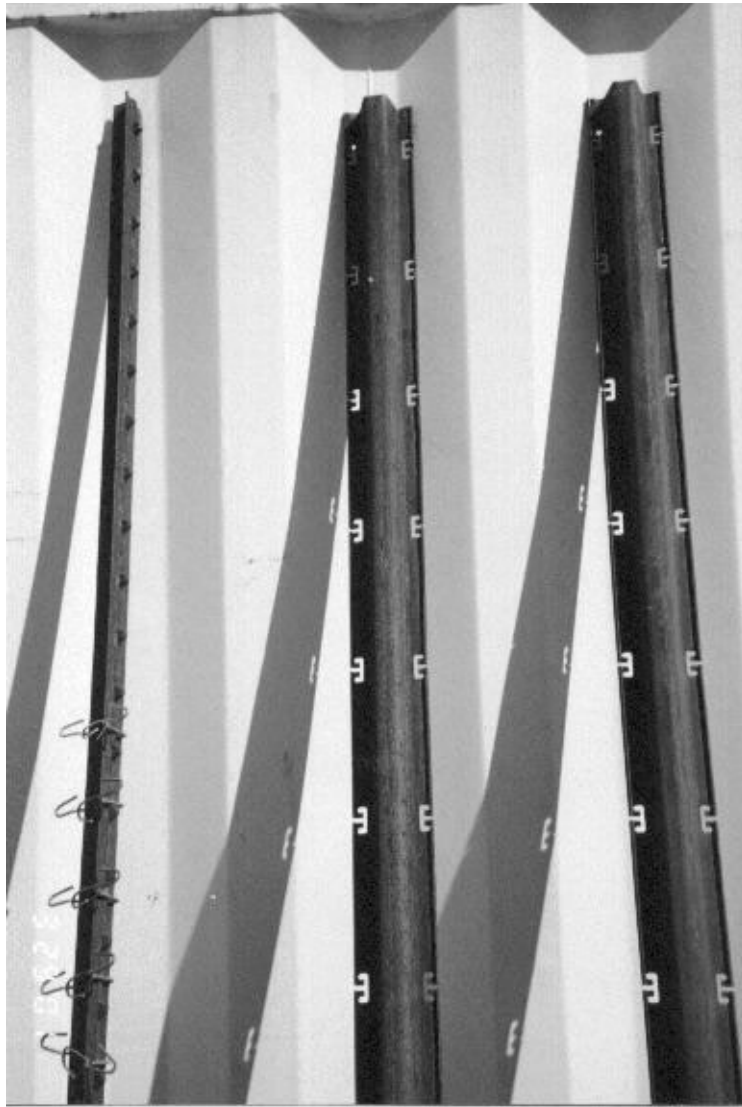

T-post with J.R. wire clips

7' heavy T-post
7' light T-post
J.R. clips



Vertical line post with wire slots

8' Vertical line post (13 ga.)

VINEYARD STAKES AND TRELLIS SYSTEMS

MISCELLANEOUS

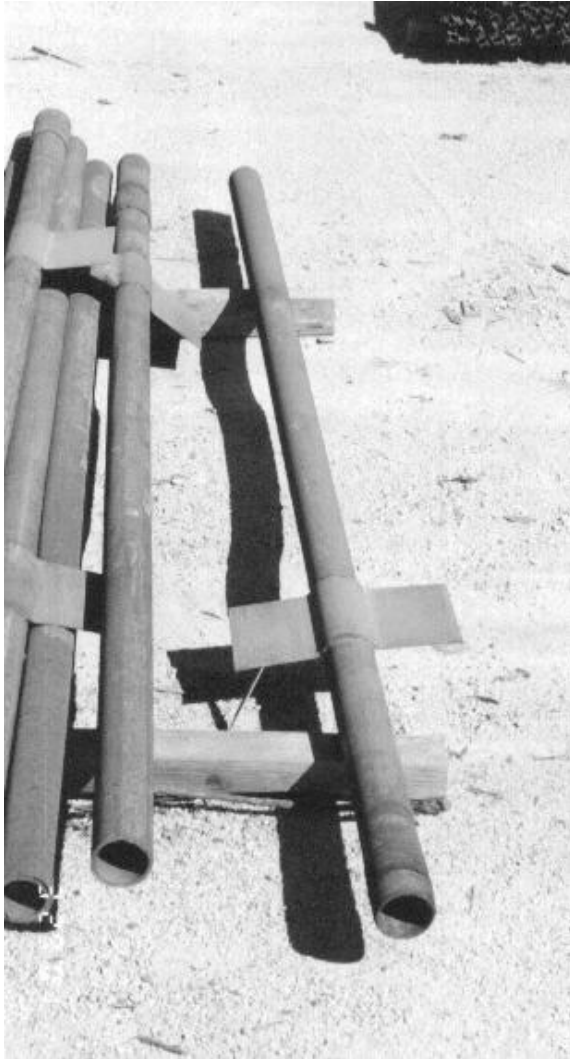

Steel end post with spade

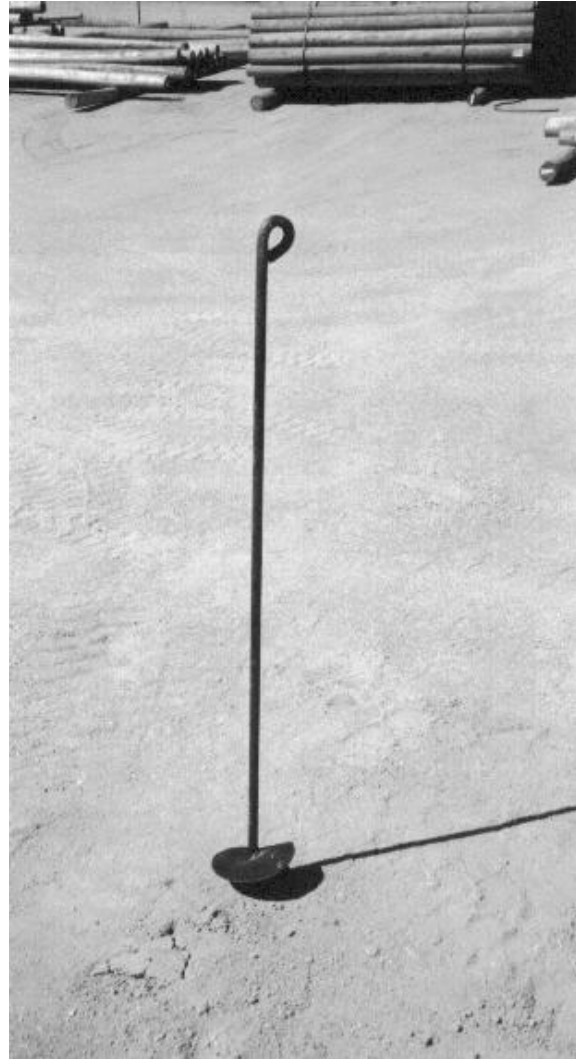

Screw-in earth anchor

VINEYARD STAKES AND TRELLIS SYSTEMS

MISCELLANEOUS

DEER FENCE



7' Deer fence made with 9' T-post and 9' wood stakes
6 ½' woven wire with 2 barbed wires on top and steel gates at drives



AH 534.78: STEEL BUILDINGS

The *all steel* building performs a variety of functions for a farmer or rancher. The most common use is storage space for farm equipment and machinery. They are also used for storage of feed and grain and other agricultural products. Steel buildings commonly house livestock for protection and security.

Steel buildings have numerous advantages over wood construction including cost-effectiveness, since steel is the least expensive method of constructing farm buildings. They have low maintenance costs to keep the structure in good working order and are not susceptible to pests, such as termites. Steel structures also withstand the elements better and are less vulnerable to fire. Additions can be added at a lower cost and they are much easier to improve with items such as windows or air conditioning.

The basic square foot building costs for a typical steel building may need to be adjusted where different specifications involving wall height, partitions, and extra electrical circuits within the structure are present. Specifications and costs for Quonset-style buildings are covered in AH 534.78, page 3. The specifications for a typical steel building are described below.

BASIC BUILDING COST

Square-foot costs of basic steel buildings include the following:

SPECIFICATIONS

Foundation	As required for normal soil conditions
Floor	Concrete slab, 4 inches to 6 inches thick with wire mesh
Frame or bents	Steel, 20, 25, or 30 feet on center
Roof purlins	Steel, 4 1/2 to 5 1/2 feet on center
Wall girts	Steel, 6 to 7 feet on center
Walls and roof	The exterior is made of 26 gauge steel
Window area	Equal to 2 percent of floor area
Lighting	Minimal light fixtures—including wiring
Ventilation	One rotary vent per bay
Doors	Two walk-in, two overhead or sliding
Eave height	14 feet

Basic steel buildings are of two types: the low profile roof pitch (1" in 12") and the more conventional barn-like roof pitch (4" in 12"). The cost differential between the two is considered immaterial for appraisal purposes.

(Photographs shown on AH 534.78, page 6)

STEEL BUILDINGS

COST PER SQUARE FOOT

Length	Width												
	20'	25'	30'	35'	40'	45'	50'	55'	60'	65'	70'	80'	
20'	\$40.03												
25'	\$38.82	\$38.10											
30'	\$37.42	\$37.11	\$36.41										
35'	\$36.06	\$35.54	\$34.74	\$33.98									
40'	\$34.70	\$33.84	\$33.05	\$32.47	\$31.10								
50'	\$33.38	\$32.47	\$31.93	\$31.38	\$30.03	\$29.88	\$29.45						
60'	\$32.53	\$31.41	\$30.50	\$30.10	\$29.50	\$29.13	\$28.75	\$28.58					
75'	\$32.18	\$30.97	\$30.33	\$29.58	\$29.05	\$28.58	\$28.21	\$27.80					
80'	\$31.53	\$30.42	\$29.65	\$28.99	\$28.58	\$28.01	\$27.62	\$27.06	\$26.43	\$25.72	\$24.99	\$24.65	
90'	\$30.76	\$29.46	\$28.75	\$28.34	\$27.82	\$27.35	\$26.82	\$26.43	\$25.85	\$25.19	\$24.41	\$23.88	
100'	\$29.46	\$28.90	\$28.27	\$27.48	\$27.16	\$26.82	\$26.22	\$25.72	\$25.19	\$24.20	\$23.54	\$23.08	
135'		\$28.41	\$27.35	\$26.37	\$25.90	\$25.61	\$25.19	\$24.97	\$24.43	\$23.68	\$22.96	\$22.82	
150'				\$25.58	\$24.94	\$24.53	\$24.15	\$24.01	\$23.68	\$23.34	\$22.69	\$22.35	
175'				\$24.89	\$24.50	\$24.20	\$23.88	\$23.65	\$23.34	\$22.82	\$22.37	\$21.98	
200'					\$24.20	\$23.90	\$23.66	\$23.34	\$22.89	\$22.36	\$21.98	\$21.73	
225'						\$23.65	\$23.34	\$22.89	\$22.30	\$22.03	\$21.77	\$21.50	
250'							\$22.89	\$22.37	\$22.03	\$21.72	\$21.57	\$21.33	

ALTERNATE COSTS

Wall Height: Add or subtract 3 percent per square foot from basic cost for each foot of variation above or below the basic 14-foot eave height.

Missing Wall Cover: Deduct **\$2.52** for each square foot of missing wall area.

Electrical Power: Deduct **\$2.13 - \$2.83** per square foot for lack of power.

The above costs are for 26 gauge steel cover.

STEEL BUILDINGS

QUONSET-STYLE BUILDINGS

Quonset-style buildings are pre-engineered structures assembled with a steel frame and galvanized steel panels on the exterior. The buildings have an arch shape with no distinction between the roof and sides. The costs provided are for a typical Quonset-style building constructed with a steel frame and exterior panels in the dimensions shown below.

Square-foot costs of basic Quonset-style steel buildings include the following:

SPECIFICATIONS

Footings	As required for normal soil conditions
Floor	Dirt
Frame	Arched steel-the width of the building at the base of the arch is generally 30 feet to 70 feet
Walls and roof	The exterior panels are made of 26 gauge galvanized steel
Window area	None
Lighting	None
Ventilation/heat	Natural-building ends are open
Doors	None

(Photograph shown on AH 534.78, page 7)

COST PER SQUARE FOOT OF BUILDING

Length	Width of Building at the Base			
	30'	40'	60'	70'
30'	\$34.34			
36'	\$32.77			
48'	\$30.53	\$27.96		
60'	\$28.86	\$26.33	\$25.07	
72'	\$27.72	\$25.14	\$24.08	\$23.08
84'	\$26.73	\$24.32	\$23.00	\$22.35
96'	\$25.73	\$23.49	\$22.35	\$21.50
108'	\$24.99	\$22.83	\$21.60	\$20.94
120'	\$24.32	\$22.77	\$21.01	\$20.28
160'	\$22.76	\$20.69	\$19.53	\$18.86
200'		\$19.53	\$18.44	\$17.96
240'		\$18.63	\$17.71	\$17.29

ALTERNATE COSTS

Electrical Power: Add **\$2.13 - \$2.83** per square foot for electrical power.

STEEL BUILDINGS

ADDITIVE COSTS

Additive costs are the in-place cost components that are not included in the basic square-foot cost. Additive costs, where appropriate, are added to the basic building cost, which results in a total building cost.

The cost of additives, such as doors and windows that replace a portion of the exterior skin of the building, reflect the net added cost of the component in-place. The cost of the skin that is replaced has been deducted from the total cost of the additive components. No further deduction is necessary.

OVERHEAD DOORS WITH CHAIN HOIST OPENER—COST PER DOOR

Width	Height				
	8'	10'	12'	14'	16'
8'	\$1,217	\$1,294	\$1,403	\$1,557	
10'	\$1,248	\$1,358	\$1,506	\$1,763	\$2,021
12'	\$1,371	\$1,500	\$1,693	\$1,943	\$2,195
14'	\$1,680	\$1,737	\$2,021	\$2,195	\$2,684
16'	\$1,847	\$2,030	\$2,317	\$2,710	\$3,012
18'	\$2,236	\$2,414	\$2,710	\$3,012	

WALK-IN DOORS

Flush 3' x 7'	\$605 to \$734
Half Glass	\$669 to \$805

ROTARY VENTS

20"	\$335
-----	-------

RIDGE VENTS

9" x 10'	\$556
12" x 10'	\$605

GUTTERS AND DOWNSPOUTS

Per linear foot	\$6.05 to \$8.69
-----------------	------------------

SKYLIGHTS

3' x 10'	\$110 to \$142
----------	----------------

WINDOWS

3' x 3'	\$200
3' x 6'	\$239
4' x 6'	\$322
4' x 8'	\$393

STEEL BUILDINGS

ADDITIVE COSTS

HEATING

Overhead Suspended Unit	Cost Per Unit
75,000 BTU	\$1,886
100,000 BTU	\$2,252
200,000 BTU	\$3,050
300,000 BTU	\$3,629

RESTROOMS

	Total Cost
Cost includes 2 fixtures, electrical service, and all partitions. Add for septic tank.	\$8,836 - \$10,940

OFFICE AREAS

	Square Foot
Cost includes partitioning, interior finish, trim, and doors	\$75 - \$98

PARTITIONS

	Per Square Foot of Wall Area
Drywall on wood frame	\$4.96
Plaster on wood frame	\$7.08
Paneling (average quality)	\$5.60 - \$7.08

INSULATION

	Square Foot
R-13	\$0.80 - \$0.94

STEEL BUILDINGS

TYPICAL STEEL BUILDINGS



STEEL BUILDINGS

QUONSET-STYLE BUILDING



AH 534.79: MISCELLANEOUS COSTS

Truck scales are used to weigh entire road or rail vehicles and their contents. By weighing the vehicle when empty and when loaded, the load carried by the vehicle can be calculated. The table below lists costs for electronic scales, as it has been found to be the most popular and most commonly purchased truck scale. Previously, this table listed costs for mechanical scales.

ELECTRONIC TRUCK SCALES WITH CONCRETE DECK

Scales			Scale Pit		
Tons Capacity	Platform Size	Total Cost	Size	Standard Cost	Add Cost for: 12' Width
20	25' x 10'	\$28,050	25' x 10'	\$23,628	\$1,307
30	25' x 10'	\$31,020	40' x 10'	\$27,192	\$1,452
50	40' x 10'	\$34,518	50' x 10'	\$30,228	\$1,597
50	50' x 10'	\$36,828	60' x 10'	\$33,660	\$1,888
60	60' x 10'	\$40,854	70' x 10'	\$34,848	\$2,178
60	70' x 10'	\$48,444	80' x 10'	\$37,686	\$3,049
60	80' x 10'	\$52,470	90' x 10'	\$27,852	
80	80' x 10'	\$55,572	90' x 10'	\$44,550	
100	90' x 10'	\$59,598	100' x 10'	\$48,576	

Mechanical scales, add 30 to 40 percent.

For pitless above-ground scales, do not add scale pit cost.

Used scales, deduct 25 to 40 percent.

ADD FOR WEIGHT RECORDING EQUIPMENT

Programmable indicator/controller **\$1,584 - \$2,640**

Ticket printer **\$792 - \$1,848**

EXAMPLE OF MOTOR TRUCK SCALE COST

Scales: 80 ton capacity, 80' x 10' platform **\$55,572**

Scale Pit: 90' x 10' size, standard **\$44,550**

Programmable weight recording equipment and printer **\$2,376**

Total **\$102,498**

(Photograph shown on AH534.79, page 10)

ELEVATED HOPPER TANK – Steel Support Legs, Stiffened Side Walls, Ladder, Roof Access Door, includes Concrete Base

Size	Cost
80 Tons	\$19,668
100 Tons	\$22,230
130 Tons	\$26,136
160 Tons	\$30,426
200 Tons	\$37,950
235 Tons	\$42,636
300 Tons	\$53,790
350 Tons	\$49,764
400 Tons	\$71,346

MISCELLANEOUS COSTS

CONCRETE HORIZONTAL OR FLAT STORAGE

Cwt	Cost per Cwt (100 lbs)
28,000	\$5.76
42,000	\$5.53
56,000	\$5.30
85,000	\$5.05
110,000	\$4.86
140,000	\$4.69
200,000	\$4.54
400,000	\$3.96
600,000	\$3.79

ABOVE-GROUND FUEL TANKS AND CONTAINMENT SYSTEMS

PREFABRICATED CONCRETE FUEL CONTAINMENT TUBS

400 gallon capacity containment	\$1,062
500 gallon capacity containment	\$1,376
1,000 gallon capacity containment	\$2,000

CONTAINMENT WITH TANK AND ELECTRIC PUMPS

500 gallon – diesel	\$6,113
1,000 gallon – diesel	\$8,327
500 gallon – gasoline	\$7,334
1,000 gallon – gasoline	\$9,628

ABOVE-GROUND FUEL TANKS (Steel Tanks with Thick Outer Shell of Concrete)

Gallons	Cost
500, with electric pump	\$11,045 to \$12,559
1,000, with electric pump	\$15,136 to \$17,406
2,000, with electric pump	\$22,463 to \$25,276
Double unit—(1) 1,000 gallon, (1) 500 gallon with 2 electric pumps	\$16,649 to \$18,686

(Photographs shown on AH 534.79, page 10)

MISCELLANEOUS COSTS

WATER TANKS

ELEVATED STEEL WATER STORAGE TANKS

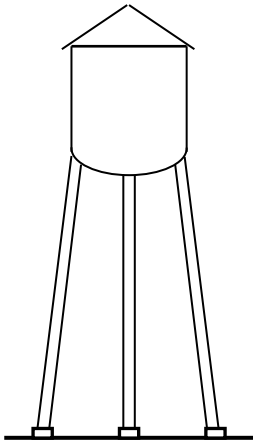
	Gallon Capacity	Total Cost of 75' Tower and Tank	Total Cost of 100' Tower and Tank
	25,000	\$395,736	\$455,862
	30,000	\$424,129	\$485,892
	40,000	\$445,830	\$499,264
	50,000	\$460,865	\$524,304
	60,000	\$480,902	\$547,008
	75,000	\$512,364	\$577,764
	100,000	\$592,178	\$624,492
	150,000	\$751,938	\$802,296
	200,000	\$930,811	\$984,654
	300,000	\$1,158,300	\$1,248,601
	500,000	\$1,556,016	\$1,663,662
	1,000,000	\$2,582,316	\$2,851,484

WELDED STEEL WATER STORAGE TANKS ON GROUND WITH FOUNDATION

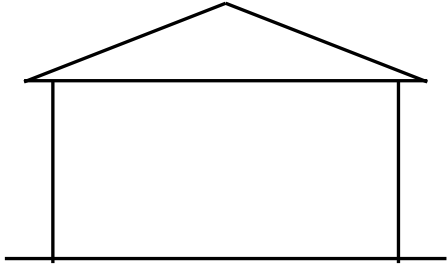
	Gallon Capacity	Total Cost of Tank on Ground
	25,000	\$83,790
	30,000	\$94,626
	40,000	\$108,108
	50,000	\$129,654
	60,000	\$146,160
	75,000	\$174,258
	100,000	\$198,324
	150,000	\$249,354
	200,000	\$282,934
	300,000	\$354,060
	500,000	\$375,228
	1,000,000	\$777,672

MISCELLANEOUS COSTS

WATER TANKS

BOLTED STEEL WATER TANKS

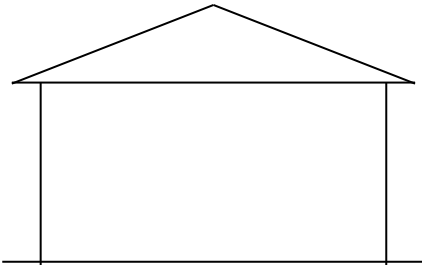
	Gallon Capacity	Total Cost of Tank on Ground
	10,000	\$29,170
	20,000	\$42,400
	30,000	\$52,732
	50,000	\$67,788
	75,000	\$81,082
	100,000	\$93,052
	125,000	\$109,746
	150,000	\$133,560
	200,000	\$158,256

Price varies due to gauge, height, diameter, and delivery costs.
Price typically includes crushed rock base or concrete on longer tanks.

POLYETHYLENE OR FIBERGLASS TANKS (Used for Ag Chemicals or Liquid Fertilizers)

Capacity (Gallons)	Cost
1,000	\$1,543
2,000	\$2,836
3,000	\$4,348
4,000	\$5,513
5,000	\$7,087
6,000	\$8,159
8,000	\$10,615
10,000	\$12,695

Add \$5.17 per square foot for concrete base.

Polyethylene water only tanks, deduct 20 percent from above prices.

MISCELLANEOUS COSTS

STEEL GRAIN BINS

Sacramento and Northern California

Steel grain bins are used for storage and drying of small grains. The typical storage bin has metal walls and roof, and a concrete floor and foundation. The drying bin is of similar construction with a dryer floor, unloading auger, and leveler. Dryer fan, heater unit, and motor are also considered part of the drying bin.

GRAIN DRYING BINS- COST PER BIN

Diameter	Eave Heights					
	16'	18'	21'	24'	32'	40'
18'	\$20,885	\$21,978	\$23,047	\$26,725	\$32,489	\$37,526
21'	\$23,821	\$24,710	\$25,840	\$30,922	\$38,106	\$42,468
24'	\$27,205	\$28,216	\$29,700	\$35,732	\$43,879	\$48,628
27'	\$32,789	\$33,858	\$35,759	\$43,110	\$53,438	\$56,774
30'	\$36,532	\$38,076	\$40,214	\$47,408	\$58,379	\$64,794
36'	\$48,340	\$50,609	\$52,866	\$62,356	\$74,160	\$84,167
42'	\$59,698	\$61,657	\$63,737	\$80,832	\$92,892	\$108,416
48'	\$76,567	\$81,200	\$86,011	\$99,821	\$113,614	\$118,616

Includes cost of foundation, perforated floor, unloading auger, aeration unit, fan, dryer, and stirring devices.

GRAIN STORAGE BINS- COST PER BIN

Diameter	Eave Heights								
	16'	18'	21'	24'	32'	40'	48'	58'	64'
18'	\$12,296	\$12,474	\$13,841	\$16,394	\$21,384	\$26,886	\$31,042		
21'	\$13,960	\$14,494	\$15,919	\$19,127	\$24,948	\$30,727	\$36,142		
24'	\$16,930	\$17,701	\$18,474	\$22,691	\$28,453	\$35,826	\$41,808	\$49,867	\$55,409
27'	\$19,306	\$20,909	\$23,464	\$27,740	\$36,175	\$42,626	\$51,694	\$62,209	\$68,630
30'	\$21,740	\$23,285	\$26,671	\$30,056	\$39,264	\$47,728	\$56,668	\$70,961	\$79,776
36'	\$29,106	\$30,769	\$34,096	\$39,085	\$49,896	\$61,705	\$74,172	\$91,739	\$101,749
42'	\$36,472	\$38,016	\$39,739	\$52,272	\$62,905	\$80,846	\$94,824	\$114,217	\$126,683
48'	\$50,490	\$54,648	\$59,519	\$67,561	\$77,993	\$99,445	\$110,816	\$134,680	\$148,218

Includes cost of bin foundation, door, ladder, and unloading auger.

ADD FOR: Roof Augers **\$1,056 to \$1,980** (depends on length—13' to 24')
 Fan **\$2,244** (5 H.P.) to **\$4,092** (25 H.P.)

(Photographs shown on AH 534.79, page 11)

PERFORATED FLOORS

18'	21'	24'	27'	30'	36'	42'	48'
\$3,366	\$3,635	\$4,578	\$5,520	\$6,866	\$9,559	\$12,252	\$14,945

MISCELLANEOUS COSTS

REDWOOD WATER STORAGE TANKS

2-INCH REDWOOD WATER STORAGE TANKS

Gallons	Diameter	Height	Cost
500	5'	4'	\$4,914
1,000	6'	6'	\$6,048
1,500	7'	6'	\$6,238
2,000	8'	6'	\$9,229
3,000	10'	6'	\$11,939
4,000	10'	8'	\$14,238
5,000	11'	8'	\$16,318
6,000	12'	8'	\$19,026
7,000	11'	10'	\$21,042
8,000	12'	10'	\$22,050
9,000	13'	10'	\$23,562
10,000	14'	10'	\$26,177
12,000	15'	10'	\$28,980
15,000	14'	14'	\$31,626

Above costs include chime joists, covers, foundation, and all labor, set up,
and transportation charges.

ADD FOR: Ladders **\$50** per linear foot
 Water level registers **\$19** per linear foot of tank height
 Cone covers **\$1,260 to \$3,780** per tank

MISCELLANEOUS COSTS

REDWOOD WATER STORAGE TANKS

3-INCH REDWOOD WATER STORAGE TANKS

Gallons	Diameter	Height	Cost
10,000	14'	10'	\$29,106
12,000	14'	12'	\$33,454
15,000	16'	12'	\$35,848
20,000	18'	12'	\$46,180
25,000	17'	16'	\$50,022
30,000	20'	14'	\$58,212
40,000	23'	14'	\$73,301
50,000	24'	16'	\$82,278
60,000	26'	16'	\$92,358
70,000	28'	16'	\$98,154
75,000	29'	16'	\$111,384
80,000	30'	16'	\$120,142
90,000	30'	18'	\$126,347
100,000	32'	18'	\$133,372
150,000	37'	20'	\$178,606
200,000	43'	20'	\$211,680
250,000	43'	25'	\$252,000

Above costs include typical foundation, chime joists, tank cover, and all labor, set up, and transportation charges.

CYLINDRICAL 3-INCH REDWOOD WINE TANKS

Gallons Capacity	Cost
1,000	\$7,434
1,500	\$9,450
2,000	\$10,962
2,500	\$13,104
3,000	\$15,498
4,000	\$16,632
5,000	\$20,286
7,500	\$25,074
10,000	\$27,720
15,000	\$39,060
20,000	\$50,778
25,000	\$55,062
30,000	\$65,268

Base price includes 4" x 6" chime joists, 1/2' galvanized hoops, recessed head cover, side door with galvanized T-bolt.

MISCELLANEOUS COSTS

STAINLESS STEEL WINE TANKS

Gallons Capacity	Cost
1,000	\$11,810
2,000	\$16,807
3,000	\$19,078
4,000	\$21,284
5,000	\$21,544
10,000	\$31,387
20,000	\$49,966
50,000	\$78,257
100,000	\$117,564
200,000	\$215,444

Cost includes all valves, temperature controls, vents, and cooling jackets for tanks with a capacity of 20,000 gallons or less. The cost on tanks of 50,000 gallons or more excludes cooling jackets.

CYLINDRICAL 2 INCH OAK TANKS

Gallons Capacity	Cost
500	\$3,125
750	\$4,586
1,000	\$5,972
1,250	\$6,616
1,500	\$8,442
2,000	\$11,933
2,500	\$13,759
3,000	\$15,713
4,000	\$20,728
5,000	\$25,326
6,000	\$30,556

Base price includes 4" x 6" chime joists, galvanized hoops, head supports with stainless steel head bolts, side door with stainless T-bolt, and installation in Sonoma County. Foundations not included.

MISCELLANEOUS COSTS

PREFABRICATED METAL SHADES

SPECIFICATIONS

Foundation	Metal base plate with tie downs
Floor	Dirt
Wall/Roof Frame	2 3/8" galvanized structural tubing (4' on center) 7' to 9' eaves
Roofing	29-gauge steel with baked on enamel (extends 6" to 12" below eaves)
Exterior Wall Covering	None

(Photograph shown on AH534.79, page 12)

COMMON SIZES

12' x 21'	\$1,518	20' x 21'	\$2,574
12' x 26'	\$1,848	20' x 26'	\$3,102
12' x 31'	\$2,376	20' x 31'	\$3,828
12' x 36'	\$2,706	20' x 36'	\$4,488
12' x 41'	\$3,102	20' x 41'	\$5,016

RV SHADES

14' x 30' x 12'	\$4,686
14' x 40' x 12'	\$6,204

ADDITIVES

- Add 6 percent to above prices for 26-gauge steel roofing.
- 29-gauge metal wall covering—**\$1.82** per square foot of wall (standard roofing extends 6" to 12" below eaves)
- Back enclosure kit:
 - 12-foot wide — **\$667**
 - 20-foot wide — **\$884**
 - 24-foot wide — **\$1,182**
- Front enclosure kit with opening for roll-up door:
 - 12-foot wide — **\$515**
 - 20-foot wide — **\$588**
- Light duty roll-up doors:
 - 8' x 6' — **\$443**
 - 9' x 7' — **\$515**
 - 10' x 8' — **\$588**
 - 10' x 10' — **\$667**
- Walk-thru door 32" x 72" — **\$298 to \$370**
- Add 3 percent for each additional foot of wall height above 8 feet.
- Concrete floor—**\$5.88 to \$7.39** per square foot
- Windows 30" x 30" — **\$185**

MISCELLANEOUS COSTS

PIT TYPE MOTOR TRUCK SCALE WITH CONCRETE DECK



ABOVE-GROUND FUEL TANK (Steel Tank with Thick Outer Shell of Concrete)



MISCELLANEOUS COSTS

STEEL GRAIN BINS

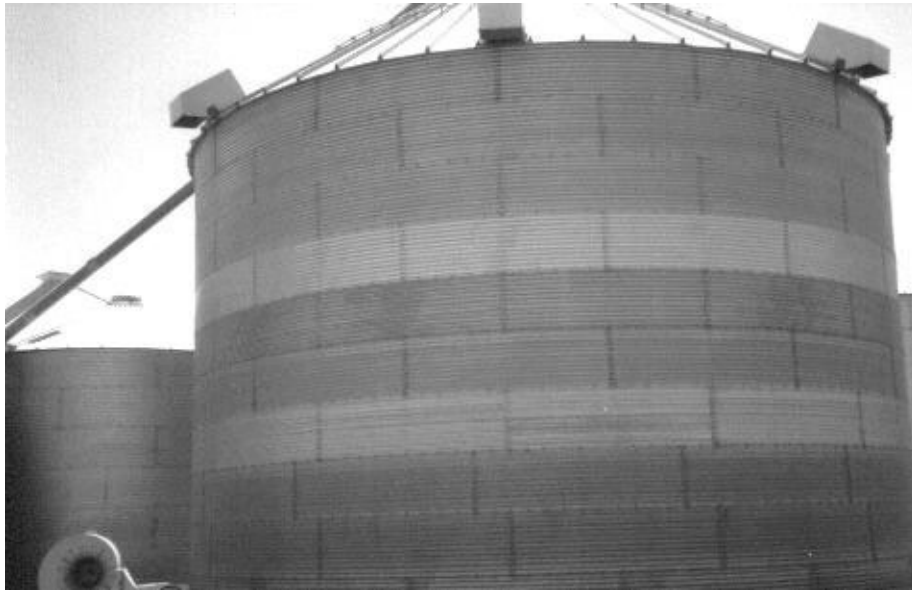
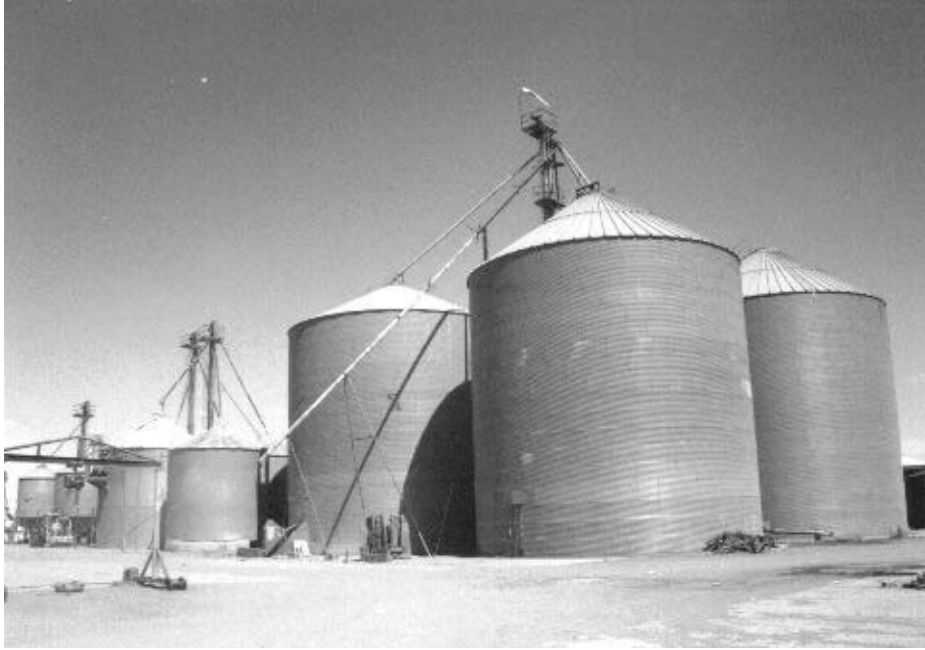

MISCELLANEOUS COSTS

PREFABRICATED METAL SHADES

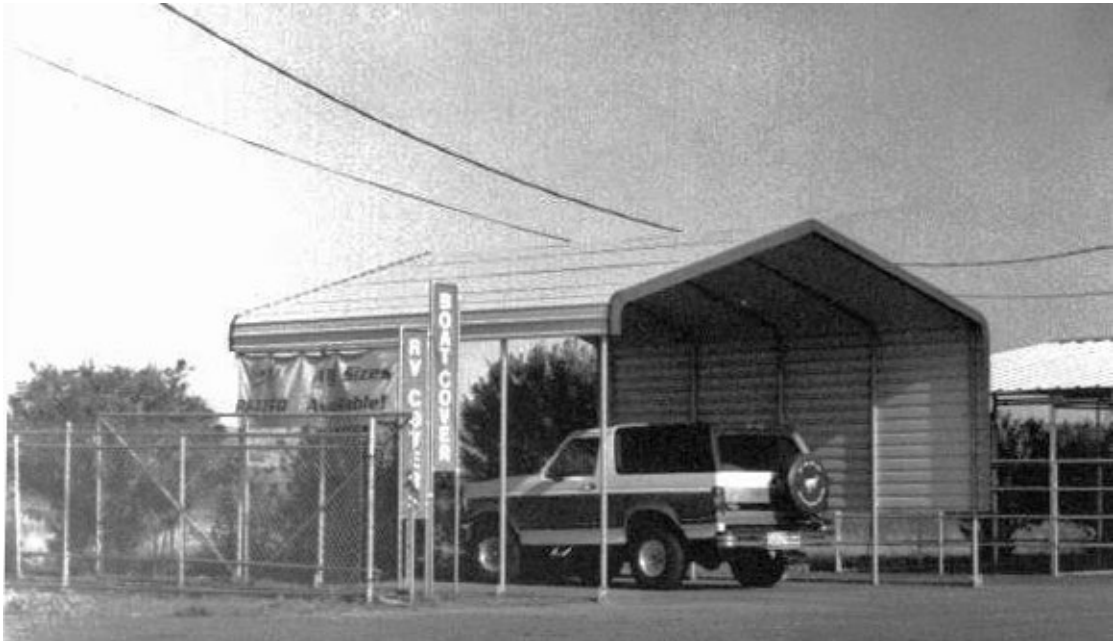

AH 534.80: WIND MACHINES

Conventional wind machines have a large fan on top of a tower. These wind machines work with temperature inversions to mix warm air with lower-lying cold air. Tower wind machines are best suited for flat, evenly shaped growing areas.

A newer design called a cold air drain has also been introduced to the market. In this design, rather than being mounted on a tower, the unit is placed at ground level. It operates by drawing in air from the sides of the unit, directing it upwards, displacing lower-lying cold air with warmer surrounding air. These machines are used where conventional tower wind machines are less effective, such as gentle slopes, rolling hills, swales, pockets, canyons, and valleys. These new design units are often used in addition to a conventional wind machine.

Photographs of these wind machines are located at the end of this chapter.

NEW

New machines have an average physical life of about 30 years. The amount of time that these machines are used varies depending on the climate, but typically averages around 100 to 150 hours per year. Each conventional wind machine will service approximately 10 acres.

CONVENTIONAL WIND MACHINES

Model	Cost
G.P. 359 Cummins Diesel	\$49,400
130 HP Ford V-10 L.P.G. *	\$40,430
130 HP F460 L.P.G.	\$33,995
115 HP John Deere 6068 Diesel	\$40,430
100 HP John Deere 4T	\$39,130
Portable Low Crop 115 HP John Deere Diesel	\$42,380
Portable Low Crop 115 HP F460 L.P.G.	\$38,350
Portable Low Crop 100 HP John Deere Diesel	\$41,145
Portable Low Crop 92 HP F300-6 L.P.G.	\$35,100

Tower height for the above machines is 36 feet.
The prices above include the foundation and installation.

OPTIONS

Item	Cost
41 Foot Tower	\$2,600
Auto Thermostat Control	\$3,250
Variable Speed Rotation	\$1,560
Contour Assembly	\$3,900
Replacement fan	\$1,560

* No longer manufactured.

WIND MACHINES

USED

The cost of used wind machines can vary widely depending upon the age and condition of the equipment.

USED PROPANE

Engine	Configuration	HP	Cost
330 Ford *	6 Cylinder	Diesel - 81 HP	\$7,280
363 Ford *	6 Cylinder	Diesel - 100 HP	\$8,840
378 Cummins *	V-6	Diesel - 125 HP	\$8,840

DIESEL MACHINES (REBUILT ENGINES)

Engine	Fuel Type /HP	Cost
292-V-8	Propane 86 HP	\$3,250
332-V-8	Propane 86 HP	\$3,250
300-6	Propane 92 HP	\$5,200
391-V-8	Propane 100 HP	\$5,200
391-V-8	Propane 125 HP	\$5,850
460-V-8	Propane 125 HP	\$5,850

The above prices include a 550 gallon above-ground fuel tank. Larger tanks are available on request at additional cost.

The cost of used wind machines can vary widely depending upon the age and condition of the equipment.

* No longer manufactured.

WIND MACHINES

RECONDITIONED

RECONDITIONED GROUND POWERED TROPIC BREEZE

Model		Cost
F300-6	Ford, Propane 92HP	\$13,750
F391	Ford, Propane 115 HP 1	\$15,950
F460	Ford, Propane 130 HP	\$19,250
In Line 6	John Deere, Diesel	\$20,350
In Line 6	Cummins, Diesel	\$20,350
V-6	Cummins, Diesel	\$20,350

115HP and 130HP machines have new fiberglass fans.

RECONDITIONED EOT

Model		Cost
391	Ford, Propane	\$13,750
460	Ford, Propane	\$17,050

NOTE: All used costs listed above include the foundation and installation.

RECONDITIONED GROUND POWERED TROPIC BREEZE

Model		Cost
F300-6	Ford, Propane 92HP	\$13,750
F391	Ford, Propane 115 HP	\$15,950
F460	Ford, Propane 130 HP	\$19,250
In Line 6	John Deere, Diesel	\$20,350
In Line 6	Cummins, Diesel	\$20,350
V-6	Cummins, Diesel	\$20,350

115HP and 130HP machines have new fiberglass fans.

RECONDITIONED EOT

Model		Cost
391	Ford, Propane	\$13,750
460	Ford, Propane	\$17,050

NOTE: All used costs listed above include the foundation and installation.

WIND MACHINES

COLD AIR DRAIN

Much newer to the marketplace than conventional wind machines, cold air drain units are becoming more commonly used. The unique design is particularly effective on gentle slopes, rolling hills, swales, pockets, canyons, and valleys where conventional tower wind machines are less effective. These units are often used to supplement conventional wind machines.

Model	Cost
# 925 Shur Farms Cold Air Drain PTO-Requires min. 10HP at 540	\$12,350
EM1 Electric Motor, 1ph, 230V	\$4,160
EM1/AS Electric Motor, 1ph, 230V with Temperature Controlled Auto-Start	\$6,760
H9 Honda Gasoline Power Unit, 9HP Electric Start	\$3,900
H15/AS/2.5 Honda Gasoline Power Unit w/ Temperature Controlled Auto -Start	\$8,320
#3510 Shur Farms Cold Air Drain (10 acres) PTO- Requires min. 35HP @ 540 RPM	\$26,000
Power options	
V35-Vanguard Gasoline Power Unit	\$7,150
#1550 Shur Farms Cold Air Drain PTO-Requires min. 15HP @ 540 RPM	\$16,900
Other Power Options For Shur Farms	
EM3-Electric Motor, 3ph, 230/460V	\$5,070
EM3/AS Electric Motor, 3ph, 230/460V Temperature Controlled Auto-Start	\$7,150
EM1-10 Electric Motor , 1ph, 230V, 10HP	\$5,200
EM1-10/AS Electric Motor , 1ph, 230V, 10HP w/ Temp Controlled Auto-Start	\$7,800
H15 Honda Gasoline Power Unit, 15HP w/ Temperature Controlled Auto-Start	\$8,320
HVT20 Honda V-Twin Gasoline Power Unit	\$5,850

WIND MACHINES

Glossary of Abbreviations

GP	Ground Power
RT	Rotating Tower
TT	Tall Tower
ST-ROT	Standard Rotation
SP-ROT	Special Rotation
LC	Low Crop
S	Single
D	Dual
EOT	Engine on Tower
SC	Special Contour

WIND MACHINES

Conventional Design



WIND MACHINES

Cold Air Drain



AH 534.90: DEPRECIATION

DEFINITIONS

An essential part of the cost approach is the estimation of depreciation, and the usefulness of this approach depends greatly upon the appraiser's ability to make this estimate. This discussion is confined to the application of normal percent good factors to replacement cost new to arrive at replacement cost less normal depreciation. A more detailed discussion of depreciation may be found in Assessors' Handbook Section 501, *Basic Appraisal*.

PERCENT GOOD TABLES

Accrued depreciation is considered to be the difference between replacement cost new and current value.

Percent good is the complement of accrued depreciation. If accrued depreciation is 20 percent, percent good is 80 percent. The percent good concept is used because it saves one arithmetic operation in calculating replacement cost new less normal depreciation.

In a mass appraisal program, speed and uniformity in depreciation estimates are accomplished by the use of normal percent good tables. Percent good factors reflect the average loss in value that improvements suffer over time from normal or usual causes. They include normal physical deterioration and normal functional obsolescence, but they do not include value losses caused by unusual physical deterioration, unusual functional obsolescence, or economic obsolescence.

There are two types of normal percent good tables for structures. They are designated as "R" and "OR" tables. "R" tables are generally applicable to residential-type buildings, and "OR" tables are applicable to "other-than-residential" buildings. For each of the two types there are a number of different tables for buildings with various life expectancies.

Individual tables are designated as type "R" or "OR," with a total life expectancy in years. For example, the proper table for an average-quality dairy barn with a 20-year total life expectancy is designated as "R-20."

AVERAGE LIFE TABLES

Average life tables direct the appraiser to the proper normal percent good table. This selection is based upon the following three factors:

- Use type
- Construction type
- Quality

Use type refers to the use that is currently being made of the improvement. It may or may not be the same as the original design type that the building cost is based upon.

Construction type and quality classification are based upon the same standards as those set forth in the standard classification system for these two building characteristics.

REMAINING LIFE EXPECTANCY TABLES

Remaining life expectancy tables are also included with the normal depreciation tables. These tables show a remaining life expectancy for an item at each age of its life. These tables are intended as general information for the appraiser and may or may not be applicable in a specific instance.

EXTENDED LIFE CONCEPT

The percent good tables incorporate an extended life concept. In this concept, percent good and remaining life expectancy are based upon the expectancy at any age of a surviving item of a larger original group. Thus, a given item that has a probable life expectancy of 20 years when new may have some remaining life and, therefore, value when it is 20 years old. This stems from the fact that the 20-year average life for the group is attained by the early retirement of some items and the later retirement of others.

EFFECTIVE YEAR

Two items must be known in order to select the proper normal percent good of a structure from the table—the average life and the age of the structure. The average life is obtained from the "average-life table" and the age is calculated by subtracting the *effective year* (see next paragraph) from the appraisal year. Normal percent good and remaining life can be found from the table by selecting the age in years from the age column and reading horizontally to the proper average life column.

In most buildings, the effective year is the same as the year of construction. Changes in effective year should not be made unless a significant change has been made in the improvement. However, when a building has been remodeled or added to, or is not architecturally representative of its date of original construction, the effective year may differ from the actual year of construction.

The assignment of an effective year is an appraisal estimate rather than a mechanical calculation. Knowledge of architectural and functional characteristics of structures and the changes in these characteristics over time is the key to estimating the effective year of structures. These characteristics cause structures to fall into eras or age groups. Age groups may be identified by the appraiser and a year that most nearly reflects the effective age of a structure is assigned.

PHYSICAL CONDITION

While the value of a building may vary considerably with its condition, effective year changes are not generally made as a result of condition. Normal percent good computations are based on the assumption that the building is in average condition for its age.

While the condition of a building does have a significant influence on its value, the effective year is not generally changed for this reason because it is a temporary situation relative to total building life. Building conditions may vary considerably in a short period of time; for example, a building

may be in poor condition one year, completely renovated the next year, and then allowed to deteriorate again. Effective year changes should be reserved for permanent situations.

Value differences due to physical condition should be considered as a step in the appraisal process that is subsequent to the computation of replacement cost new less depreciation (RCNLD).

The estimation of an effective year is dependent upon the appraiser's knowledge and judgment. At best, an average age of construction tends to set the latest year that should be assigned for effective age.

DEPRECIATION

AVERAGE LIFE TABLES

MISCELLANEOUS IMPROVEMENTS

<u>Use Type of Improvement</u>	<u>Quality/Type</u>	<u>Type of Schedule</u>	<u>Average Life</u>
Barns (General Farm)	Poor	R.	20
Barns (General Farm)	Fair	R.	30
Barns (General Farm)	Good	R.	40
Barns (General Farm)	Excellent	R.	60
Barns, Dairy	Poor	R.	20
Barns, Dairy	Average	R.	20
Barns, Dairy	Good	R.	25
Cold Storage Food Lockers	Poor	O.R.	30
Cold Storage Food Lockers	Average	O.R.	40
Cold Storage Food Lockers	Good	O.R.	50
Cold Storage Warehouses	Poor	O.R.	40
Cold Storage Warehouses	Average	O.R.	50
Cold Storage Warehouses	Good	O.R.	60
Cotton Gins		O.R.	30
Drive-In Theaters	Poor	O.R.	20
Drive-In Theaters	Good	O.R.	30
Drying Sheds (Fruits & Nuts) (Wood Frame)	Poor	R.	10
Drying Sheds (Fruits & Nuts) (Wood Frame)	Fair	R.	20
Drying Sheds (Fruits & Nuts) (Wood Frame)	Good	R.	30
Fences, Wood or Wire	Poor	R.	10
Fences, Wood or Wire	Average	R.	20
Fences, Wood or Wire	Good	R.	30
Fences, Chain Link, Residence-Farm	Light	R.	20
Fences, Chain Link, Industrial-Commercial	Good	R.	30

DEPRECIATION

AVERAGE LIFE TABLES

MISCELLANEOUS IMPROVEMENTS

<u>Use Type of Improvement</u>	<u>Quality/Type</u>	<u>Type of Schedule</u>	<u>Average Life</u>
Frost Protection Wind Machines		R.	30
Grain Elevators	Concrete and Metal	O.R.	50
Grain Storage Bins	Metal	O.R.	40
Grain Storage Bins	Concrete	O.R.	60
Greenhouses, Commercial	Poor Wood Frame	O.R.	20
Greenhouses, Commercial	Average	O.R.	30
Greenhouses, Commercial	Good	O.R.	40
Greenhouses, Conservatory (Back Yard)	Poor	R.	10
Greenhouses, Conservatory (Back Yard)	Good	R.	20
Hog and Sheep Sheds and Corrals	Poor	R.	10
Hog and Sheep Sheds and Corrals	Fair	R.	20
Hog and Sheep Sheds and Corrals	Good	R.	30
Lath Houses	Poor	R.	10
Lath Houses	Fair	R.	20
Lath Houses	Good	R.	30
Motor Truck Scales	Wood Under-structure	O.R.	30
Motor Truck Scales	Wood Under-structure	O.R.	40
Poultry Houses	Poor	R.	10
Poultry Houses	Medium	R.	20
Poultry Houses	Good	R.	30
Rice Drying and Storage Plants	Concrete and Metal	O.R.	50

DEPRECIATION

AVERAGE LIFE TABLES

MISCELLANEOUS IMPROVEMENTS

<u>Use</u> <u>Type of Improvement</u>	<u>Quality/Type</u>	<u>Type of Schedule</u>	<u>Average Life</u>
Service Stations	Poor Wood Frame	O.R.	20
Service Stations	Good Wood Frame, or Light Steel, or Masonry	O.R.	25
Service Stations	Good Wood Frame, or Light Steel, or Masonry	O.R.	30
Silos, Wood	Poor	R.	20
Silos, Wood	Good	R.	30
Silos, Masonry - Tile and Basalite		R.	40
Silos, Masonry - Concrete		R.	50
Steel Building, Quonset or Straight Wall Type (Steel Frame)	Light	O.R.	40
Steel Building, Quonset or Straight Wall Type (Steel Frame)	Medium	O.R.	50
Steel Building, Quonset or Straight Wall Type (Steel Frame)	Heavy	O.R.	60
Storage Sheds (Frame)	Poor	R.	20
Storage Sheds (Frame)	Fair	R.	30
Storage Sheds (Frame)	Good	R.	40
Swimming Pools	Poor	R.	10
Swimming Pools	Fair	R.	20
Swimming Pools	Good	R.	30
Water Tanks, Elevated	Wood Frame and Tank	O.R.	30
Water Tanks, Elevated	Wood Frame and Tank	O.R.	60

Poor = Poorest grade of materials; not contractor erected.
 Fair = Average materials; builder erected.
 Good = Good materials; good design; erected by competent builder.

DEPRECIATION

NORMAL PERCENT GOOD TABLES - RESIDENTIAL BUILDINGS

Age Years	20 Years Avg Life		25 Years Avg Life		30 Years Avg Life		40 Years Avg Life	
	Rem Life Years	Percent Good	Rem Life Years	Percent Good	Rem Life Years	Percent Good	Rem Life Years	Percent Good
0	20	100	25	100	30	100	40	100
1	19	94	24	95	29	96	39	98
2	18	88	23	90	28	93	38	96
3	17	81	22	86	27	89	37	94
4	16	75	21	81	26	86	36	92
5	15	69	20	77	25	82	35	90
6	14	63	19	72	24	79	34	87
7	13	59	18	68	23	75	33	84
8	12	57	17	63	22	71	32	82
9	11	55	16	60	21	67	31	80
10	11	53	16	58	20	64	30	77
11	10	50	15	56	19	60	29	74
12	9	48	14	54	19	59	28	72
13	8	46	13	53	18	57	27	70
14	7	44	12	51	17	56	27	67
15	7	42	11	49	16	54	26	65
16	6	40	11	48	15	53	25	62
17	5	38	10	46	14	52	24	60
18	5	36	9	44	13	50	23	59
19	4	33	8	43	13	49	22	58
20	4	31	7	41	12	47	21	56
21	3	29	7	39	11	46	21	55
22	3	27	6	37	11	44	20	54
23	3	25	6	35	10	43	19	53
24	3	23	5	34	9	42	18	52
25	2	21	5	32	9	40	17	51
26	2	19	4	30	8	39	17	50
27	2	16	4	29	7	37	16	49
28	2	14	4	27	7	36	15	48
29	2	12	3	25	6	34	14	47
30	1	10	3	24	6	33	14	46
31			3	22	5	31	13	45
32			3	20	5	30	12	44
33			2	18	5	29	12	43
34			2	17	4	17	11	42
35			2	15	4	26	11	41
36			2	13	4	24	10	40
38			1	10	3	21	9	38
40					2	19	7	35
42					2	16	6	33
46					1	10	5	29
50							4	25
55							3	20
60							2	14
64							1	10

DEPRECIATION

NORMAL PERCENT GOOD TABLES - RESIDENTIAL BUILDINGS

Age Years	45 Years Avg Life		50 Years Avg Life		55 Years Avg Life		60 Years Avg Life	
	Rem Life Years	Percent Good	Rem Life Years	Percent Good	Rem Life Years	Percent Good	Rem Life Years	Percent Good
0	45	100	50	100	55	100	60	100
2	43	97	48	97	53	98	58	98
4	41	93	46	94	51	96	56	96
6	39	89	44	91	49	94	54	94
8	37	85	42	88	47	91	52	92
10	35	81	40	85	45	88	50	90
12	33	77	38	82	43	85	48	88
14	32	73	36	78	41	82	46	86
16	30	69	35	74	40	79	45	83
18	28	65	33	70	38	76	43	80
20	26	60	31	67	36	73	41	77
22	24	58	29	63	34	69	39	74
24	23	56	28	60	32	65	37	71
26	22	54	26	58	31	62	35	68
28	20	52	24	56	29	60	34	65
30	18	50	23	54	27	58	32	63
32	17	48	21	53	26	56	30	60
34	15	47	20	51	24	55	29	58
36	14	45	18	49	23	53	27	57
38	12	43	17	47	21	51	26	55
40	11	41	16	45	20	50	24	54
42	10	39	14	44	19	48	23	52
44	9	37	13	42	17	46	21	51
46	8	35	12	40	16	45	20	49
48	7	33	11	38	15	43	19	47
50	6	31	10	37	14	41	18	46
52	5	29	9	35	12	40	16	44
54	5	28	8	33	11	38	15	43
56	4	26	7	31	10	36	14	41
58	4	24	6	30	9	35	13	40
60	3	22	5	28	8	33	12	38
62	3	20	4	26	7	31	11	37
64	3	18	4	24	6	30	10	35
66	2	16	3	22	5	28	9	33
68	2	14	3	21	5	27	8	32
70	2	12	3	19	4	25	7	30
72	1	10	2	17	4	23	6	29
76			2	14	3	20	5	26
80			1	10	2	17	4	23
84					1	10	2	16
96							1	10

DEPRECIATION

NORMAL PERCENT GOOD TABLES - OTHER THAN RESIDENTIAL BUILDINGS

Age Years	20 Years Avg Life		25 Years Avg Life		30 Years Avg Life		35 Years Avg Life	
	Rem Life Years	Percent Good	Rem Life Years	Percent Good	Rem Life Years	Percent Good	Rem Life Years	Percent Good
0	20	100	25	100	30	100	35	100
1	19	95	24	97	29	98	34	99
2	18	90	23	93	28	96	33	97
3	17	85	22	90	27	93	32	95
4	16	79	21	86	26	90	31	93
5	15	73	20	82	25	88	30	91
6	14	67	19	78	24	85	29	89
7	13	61	18	74	23	82	28	87
8	12	56	17	70	22	79	27	85
9	11	51	16	65	21	75	26	83
10	10	49	15	60	20	72	25	80
11	9	48	14	56	19	68	24	78
12	9	46	13	52	18	65	23	75
13	8	44	12	50	17	61	22	72
14	7	43	11	48	16	58	21	69
15	6	43	10	47	15	54	20	66
16	6	41	9	46	14	50	19	63
17	5	39	8	45	13	49	18	60
18	5	38	8	44	12	48	17	57
19	5	37	7	43	12	47	16	54
20	4	35	7	42	11	47	15	51
21	4	34	6	41	11	46	14	50
22	4	33	6	40	10	45	13	49
23	3	32	5	39	10	44	13	48
24	3	30	5	38	9	43	12	47
25	3	29	5	37	9	43	12	47
26	3	28	4	36	8	42	11	46
27	2	27	4	35	8	41	11	45
28	2	25	4	34	7	40	10	44
29	2	24	4	33	7	39	10	43
30	2	22	3	32	6	38	9	43
31	2	21	3	31	6	37	9	42
32	1	20	3	30	5	36	8	42
33			3	29	5	35	8	41
34			3	28	5	35	7	40
35			2	27	5	34	7	39
36			2	26	4	33	6	38
38			2	24	4	32	6	37
40			2	22	3	30	5	36
42			1	20	3	28	5	34
45					2	26	4	32
48					2	23	3	30
52					1	20	3	27
56							2	24
62							1	20

DEPRECIATION

NORMAL PERCENT GOOD TABLES - OTHER THAN RESIDENTIAL BUILDINGS

Age Years	40 Years Avg Life		45 Years Avg Life		50 Years Avg Life		55 Years Avg Life	
	Rem Life Years	Percent Good	Rem Life Years	Percent Good	Rem Life Years	Percent Good	Rem Life Years	Percent Good
0	40	100	45	100	50	100	55	100
2	38	98	43	99	48	99	53	99
4	36	96	41	97	46	98	51	98
6	34	93	39	95	44	97	49	97
8	32	90	37	93	42	95	47	96
10	30	86	35	90	40	93	45	95
12	28	82	33	87	38	91	43	94
14	26	78	31	84	36	88	41	92
16	24	73	29	81	34	85	39	90
18	22	68	27	77	32	82	37	88
20	20	63	25	73	30	80	35	86
22	18	58	23	69	28	77	33	83
24	17	53	21	65	26	73	31	80
26	15	50	20	60	24	69	29	77
28	14	48	18	55	23	65	27	74
30	13	47	17	50	21	61	26	71
32	11	45	15	49	20	57	24	67
34	10	44	14	48	18	53	22	63
36	9	43	13	47	17	50	21	59
38	8	42	12	46	16	48	19	55
40	8	40	11	44	14	47	18	52
42	7	39	10	43	13	46	17	50
44	6	38	9	42	12	45	16	49
46	6	36	8	41	11	44	15	48
48	5	35	7	40	10	43	14	47
50	5	34	7	38	10	42	13	45
52	4	32	6	37	9	41	12	44
54	4	31	6	36	8	40	11	43
56	3	30	5	35	8	39	10	42
58	3	29	5	34	7	38	9	41
60	3	27	4	32	7	37	9	40
62	2	26	4	31	6	36	8	39
64	2	25	4	30	6	35	8	38
66	2	24	3	29	5	34	7	37
68	2	22	3	28	5	33	7	36
70	2	21	3	27	4	32	6	36
72	1	20	3	25	4	31	6	35
74			2	24	5	30	5	34
76			2	23	3	28	5	32
82			1	20	3	26	4	30
84					2	24	4	29
88					2	22	3	27
92					1	20	2	25
96							2	23
102							1	20

DEPRECIATION

NORMAL PERCENT GOOD TABLES - OTHER THAN RESIDENTIAL BUILDINGS

Age Years	60 Years Average Life		70 Years Average Life	
	Remaining Life Years	Percent Good	Remaining Life Years	Percent Good
0	60	100	70	100
2	58	99	68	99
4	56	99	66	99
6	54	98	64	99
8	52	97	62	98
10	50	96	60	98
12	48	95	58	97
14	46	94	56	96
16	44	93	54	96
18	42	92	52	95
20	40	89	50	94
22	38	87	48	93
24	36	85	46	92
26	34	83	45	91
28	32	81	42	89
30	30	78	40	87
32	29	75	39	85
34	27	72	37	83
36	25	69	35	81
38	24	66	33	79
40	22	63	31	76
42	21	60	30	73
44	20	56	29	70
46	18	52	27	67
48	17	49	26	64
50	16	48	25	61
52	15	47	23	58
54	14	46	22	56
56	13	46	21	54
58	12	45	20	52
60	11	44	19	50
64	10	42	17	48
68	9	40	15	46
72	8	38	13	44
76	7	36	12	43
80	6	35	11	41
86	5	32	9	39
92	4	29	8	36
100	3	25	6	33
108	2	22	4	29
112	1	20	3	27
122			2	24
130			1	20